

FREESTYLE™



Operation Manual
Version 1.2

Indian Creek
www.icdpaintball.com

1019 First Street North Nampa ID 83687 (208) 468-0446 phone (208) 468-6650 fax

RULES FOR SAFE MARKER HANDLING

- 1. Treat every marker as if it were loaded.**
- 2. Never look down the barrel of a paintball marker.**
- 3. Keep your finger off the trigger until ready to shoot.**
- 4. Never point the marker at anything you don't wish to shoot.**
- 5. Keep the marker on safe until ready to shoot.**
- 6. Keep the barrel blocking device in/on the marker's muzzle when not shooting.**
- 7. Always remove paintballs and propellant source before disassembly.**
- 8. After removing propellant source, point marker in safe direction and discharge until marker is degassed.**
- 9. Store the marker unloaded and de-gassed in a secure place.**
- 10. Follow warnings listed on propellant source for handling and storage.**
- 11. Do not shoot at fragile objects such as windows.**
- 12. Every person within range must wear eye, face, and ear protection designed specifically to stop paintballs and meeting ASTM standard F1776.**
- 13. Always measure your marker's velocity before playing paintball and never shoot at velocities in excess of 91.44 meters (300 feet) per second.**

INSTRUCTION MANUAL
Version 1.2
Indian Creek Design, Inc.
Model 2005 FreeStyle
Copyright 1992.... 2005

TABLE OF CONTENTS

Statement of Liability.....	4
Limited Warranty.....	5
Overview.....	6
Operation.....	6
Firing the <i>FREESTYLE</i>	8
Unloading the <i>FREESTYLE</i>	9
Maintenance.....	9
Storage and Transportation.....	10
Adjusting the Trigger Pull.....	11
Tuning Guide.....	12
Troubleshooting Guide.....	13
Pictures and Schematics	
Tools you will need.....	16
Replacing the Battery.....	17
Accessing the Electronics and Trigger.....	18
Field-Stripping.....	19
Lubricating the Cylinder.....	20
Maintaining your Regulators.....	21
Cleaning the Ball Detents.....	22
Adjusting the Low Pressure Regulator.....	23
Adjusting the High Pressure Regulator.....	24
Schematics Part 1.....	25
Schematics Part 2.....	26

INSTRUCTION MANUAL

Version 1.2

Indian Creek Design, Inc.

Model 2005 FreeStyle

Copyright 1992.... 2005

All Rights Reserved

No part of this document may be copied or reproduced in any form or by any means without the prior written consent of **Indian Creek Design, Inc., its assigns and/or its distributors.**

Notice is hereby given that this manual is part of the article owned in whole by Indian Creek Design, Inc., its assigns and/or its distributors, known as indicated in this manual and drawings. All rights of manufacture and reproduction of such articles or any part thereof are reserved by Indian Creek Design, Inc., its assigns and/or its distributors. Neither said article nor any part thereof may be manufactured or reproduced except by written authorization from Indian Creek Design, Inc., its assigns and/or its distributors. All proprietary rights and information are the sole property of Indian Creek Design, Inc., its assigns and/or its distributors.

STATEMENT OF LIABILITY

Indian Creek Design, Inc., delivers this marker with the understanding that **Indian Creek Design, Inc., its assigns and/or its distributors**, assumes no responsibility for its resale or safe handling. Serious injury or death may occur if mishandled, abused, or the safety instructions are ignored. **Indian Creek Design, Inc., its assigns and/or its distributors** assumes no responsibility for physical injury or property damage resulting from its use.

Indian Creek Design, Inc., its assigns and/or its distributors, makes no warranties with respect to this documentation and disclaims any implied warranties of merchantability or fitness for a particular purpose. The information in this document is subject to change without notice. **Indian Creek Design, Inc., its assigns and/or distributors** assumes no responsibility for any errors that may appear in this document.

WARNING:

This is not a toy. Misuse may cause serious injury or death. Eye protection designed specifically for paintball use must be worn by the user and any person within range. Recommend 18 years of age or older to purchase. Persons under 18 years of age must have adult supervision. Obey all local, state and federal laws. Follow the rules of safe paintball marker handling. READ OWNER'S MANUAL BEFORE USING.

INDIAN CREEK DESIGN, INC.
LIMITED WARRANTY

Indian Creek Design, Inc., warrants the replacement of any original part due to defect in materials and/or workmanship of this marker. This warranty will be in effect for twelve (12) months for parts and twelve (12) months for labor following the original date of purchase for the original purchaser. Such warranty service will be provided only if the warranty registration card included with this manual is filled in completely and on file at **Indian Creek Design, Inc.** All other service will be duly charged for and returned via UPS C.O.D.

Indian Creek Design, Inc., will replace without charge any original part that is determined by Indian Creek Design, Inc., to be defective under the terms of this warranty. However, shipping charges are not covered hereunder. Failure due to an accident, abuse, neglect, modification, normal wear, operator error, maintenance by other than an authorized **Indian Creek Design, Inc.**, dealer, or use of parts inconsistent with the use originally intended for the marker as sold, is not covered by this warranty.

There are no other warranties or guarantees, expressed or implied, made by **Indian Creek Design, Inc.**, on this marker. The sole and exclusive liability of **Indian Creek Design, Inc.**, and/or its authorized dealers, affiliates, or agents pursuant to this warranty will be for repair or replacement of the defective part; incidental or consequential damages are expressly excluded hereunder.

Indian Creek Design, Inc., its authorized dealers, affiliates, or agents, will not be liable under this warranty, nor under any state or federal law, or the common law or otherwise for any damage or failure, including personal injury, resulting from such use and/or alteration. This warranty gives you specific legal rights, and you may also have other rights that may vary from state to state.

For warranty parts, service or information contact:

Indian Creek Design, Inc.
1019 First Street North
Nampa, Idaho 83687
(208) 468-0446

FreeStyle OVERVIEW

The *FreeStyle* is a quality marking instrument specially designed to meet the needs of the professional style tournament player. The *FREESTYLE* is an electronic solenoid actuated computer controlled marker. The major components of the *FREESTYLE* are machined from solid, aircraft-grade aluminum, and then hard anodized per military specifications. No castings are used in the construction of the *FREESTYLE*, thereby providing the end user with a high-quality, precision-engineered marker.

Paintball markers get a lot of abuse. Indian Creek Design, Inc., has built the *FREESTYLE* with this in mind. All internal parts, wear and contact surfaces have been heat treated or hard anodized. The toughest and most resilient materials and components have been used in the design of this product.

The *FREESTYLE* uses a single standard 9-volt battery for operation. The circuitry is a microprocessor based digital controller.

The *FREESTYLE* operates on low-pressure. The main operating pressure is 350-400 PSI nominally adjusted to visually via the gauge on the primary (input) regulator. The secondary pressure is factory pre-set and regulated to 85-95 PSI. Gas usage is controlled through these 2 internal regulators. A unique feature of this marker is the regulator adjustment. This allows precise adjustment for the velocity control of the marker and for optimal gas efficiency.

The *FREESTYLE* comes with a removable barrel system. This feature allows the user to select a barrel that is most suitable for the playing conditions. All barrels are honed with straight and spiral tip porting and stock length is 11".

OPERATION

Read the entire manual before you prepare your *FREESTYLE* for play. Safety and safe marker handling are the most important aspects of paintball sports. Please practice each of the following steps with an **unloaded** marker before attempting to charge your marker with compressed air and paintballs. **Do not load compressed air and paintballs into your *FREESTYLE* until you feel completely confident with your ability to handle your *FREESTYLE* safely.**

Keep your finger out of the trigger guard and away from the trigger; point the muzzle of the marker in a safe direction at all times. Keep the marker turned off until ready to operate. The *FREESTYLE* uses an on-off switch for one of its safety devices. ***Always keep your *FREESTYLE* pointed in a safe direction. Always use a barrel plug or barrel blocking device. Remember that the ultimate safety device is you, the operator.***

Installing the 9 volt Power Source

The *FREESTYLE* requires a single 9-volt battery as the electronic power source. The use of

long life batteries is recommended.

The 9-volt battery is located in the grip behind the trigger. The battery is accessed through the grip panel located on the right grip located on the right side of the marker.

Remove the 2 screws that hold the grip panel in place. Connect the battery to the terminal and place the battery inside the frame carefully being sure that the black and red wires to the terminal are toward the top. Make sure that there are no abrupt kinks and the wires are comfortably placed, do not force them into place. Replace the grip panel and 2 screws.

Compressed Air usage

The ***FREESTYLE*** comes with a female ¼” Push-In fitting adapter on the input of the regulator. The ***FREESTYLE*** can be set up to use a nitrogen or compressed air system. Although it may be used, CO₂ is not recommended for use as the propellant. Generally the CO₂ that we use as an industry is industrial grade CO₂. It is dirty, pumped from large tanks full of contaminants including dirt, rust and metal flakes. CO₂ can be used most successfully if used with anti-siphon systems and filters. Be aware that under the conditions of CO₂ the results may not be as expected. Consult the place where you purchased your ***FREESTYLE***, or a recognized and competent airsmith, for instruction in the safe handling of compressed-air cylinders before purchasing or connecting one to your ***FREESTYLE***.

Adjustable regulator compressed air systems:

The input pressure from your compressed air system should be regulated down to 550-600 PSI output pressure. Use a VERY HIGH FLOW low pressure output tank and regulator set-up for your best results. The ***FREESTYLE*** will work just fine with a pre-set regulated tank or an adjustable output regulated tank. Note: on MOST systems, there is a large difference between the setting pressure and the actual output operating pressure. If your compressed air system does not have an output pressure gauge on its regulator we do not recommend its use.

Fixed output regulated compressed air systems:

The ***FREESTYLE*** will work just fine with a pre-set tank. Although, you will get much better performance from a HIGH FLOW low output pressure tank/regulator than with a high pressure (750-850) output. VERIFY the output pressure from the regulator. If your compressed air system does not have an output pressure gauge on its regulator we do not recommend its use.

CO₂ usage:

Although it may be used, CO₂ is ***not*** recommended for use as the propellant. Generally the CO₂ that we use as an industry is industrial grade CO₂. It is dirty, pumped from large tanks full of contaminants including rust and metal flakes. CO₂ can be used most successfully if used with anti-siphon systems and filters. Be aware that the use of CO₂ may result in less than optimal

performance. CO2 use is NOT covered under warranty.

REMEMBER: CO2, compressed air or nitrogen systems can be extremely dangerous if misused or improperly handled. Use only cylinders meeting D.O.T. specifications. Do not perform any work to your tank or tank regulator. NEVER disassemble your tank or tank regulator. Only a qualified and trained technician should perform work to your tank and tank regulator.

Before pressurizing your **FREESTYLE**, check to make sure that you and anyone within range are wearing eye protection designed specifically for paintball. Be sure you have a barrel plug, sock, or barrel-blocking device in place and there are no paintballs in the marker. The on-off switch should be OFF. Air can now be applied, the marker will become pressurized and the bolt will slide backwards.

Paintball and Loader Usage

The **FREESTYLE** comes equipped to accept 1.03" OD standard-gravity feed loaders. Fit the loader directly into the vertical feed tube. Always twist it down in a CLOCKWISE direction. Always twist it off in a CLOCKWISE direction as well. The **FREESTYLE** uses .68 caliber, water-soluble paintballs. The paintballs are gravity fed from the loader through the direct vertical feed nipple and into the breech of the marker.

Modes - Rate of Fire –

The 2005 **FREESTYLE** features a single mode of fire.

1. The **FREESTYLE** is set for Semi-auto or single shot per trigger pull mode only.
2. The cycle rate is set extremely fast.
3. The Paintball Detection System (PDS) is turned on and off by the trigger when the marker is first turned on.

Firing the FREESTYLE

Keep your finger out of the trigger guard and away from the trigger; point the muzzle of your marker in a safe direction at all times during this process. Be sure your goggles are securely in place. Push the on-off toggle switch into the off position.

Always keep your FREESTYLE pointed in a safe direction!

1. Place the empty loader onto the marker. Be sure that it is securely mounted in place.
2. Apply the compressed gas, pressurizing the marker.
3. Put the paintballs into the loader.
4. Remove the barrel plug, sock or barrel blocking device.
5. Aim the marker at the target.

6. Push the on-off switch to the ON position, the LED will light up.
7. Place your finger on the trigger.
8. Pull the trigger with a smooth squeezing motion. **BANG. . . .**

UNLOADING THE *FREESTYLE*

Keep your finger out of the trigger guard and away from the trigger; point the muzzle of your marker in a safe direction during this entire process. *Always keep your **FREESTYLE** pointed in a safe direction!*

1. Push the on-off switch to the off position. The LED will be off.
2. Place the barrel plug, sock or barrel blocking device into the end of the barrel.
3. Remove the pressurized gas from the marker carefully.
4. Tilt the marker so that the loader is lower than the body of the marker.
5. Remove the paintball loader from the direct vertical-feed tube, turning the loader in a clockwise direction.
6. Inspect the inside of the direct vertical-feed tube to be sure that a ball does not remain inside the breech.
7. Remove the barrel and make sure there is no ball in the barrel and double-check the breech area for the presence of a paintball.
8. Remove and discard any paintballs that are found in the barrel or breech.

MAINTENANCE

CAUTION: Before attempting to perform any maintenance operations or any marker disassembly, make sure that *all* paintballs and propellant sources have been removed from the marker. Install a barrel blocking device, push the on-off switch to the OFF position and keep the marker in this "SAFE" mode.

Simple Maintenance

Keep your *FREESTYLE* clean and lubricated to eliminate the friction that would prevent reliable operation. Clean and lube the marker before each use, and do not put it away dirty. USE NO OILS! Do not use oils made for paintball markers, real firearms or pneumatic tools, do not use oils at all. Do *not* use petroleum-based lubricants in the lubrication of this marker. Teflon or silicon spray lubricants may be used for lubrication for the bolt area only of the main housing. Lithium grease such as Dow 33 is recommended for lubricating the regulator pistons and the cylinder assembly. Be sure it is Lithium Grease and not axel grease.

Cleaning Paint from the Barrel

Unscrew the barrel to remove the barrel for swabbing/cleaning. Keep the barrel clean to insure the continued accuracy of the *FREESTYLE*. Gelatin from the paintballs has a tendency to build

up in the barrel. As part of your cleaning ritual, wash out the barrel with hot soapy water and rinse it well.

PDS (paintball detection system)

The PDS (paintball detection system) is designed to detect whether or not a paintball is seated in the breach ready to fire. ***If a paintball is not there, it will not cycle.*** To dry fire the marker without the PDS system, hold in the trigger while turning the marker on. If you attempt to dry fire the marker with the PDS on, the marker will only fire once and then stop firing. Keep the infrared emitters and detectors clean for your best results.

Removing the Bolt/Cylinder Assembly (Field Stripping)

Remove the paintballs and pressurized gas from the marker. ***The FreeStyle may not be field-stripped while pressurized.***

1. Remove the screw from the back of the marker. Pull the bolt/cylinder assembly out the back of the main body.

Once the bolt assembly is removed, it is possible to clean the entire upper receiver of the marker, including the breech and feed tube area. You may slightly lubricate the rear section of the bolt with a light synthetic spray before re-installing the bolt. Do ***not*** use petroleum/oil-based lubricants. The bolt tip is ***NOT*** a simple plastic; it is a natural Delrin acetate material, which is a Dupont 3M material, developed specifically for this type of application. ***The use of a metal tipped bolt will void all warranties.***

1. Point the barrel downward and slide the bolt/cylinder assembly in until flush with the rear of the marker and the screw hole lines up in the back. Re-insert the screw and tighten until hand-tight.

STORAGE AND TRANSPORTATION

- Your ***FREESTYLE*** must be clear of all paint and propellant when not being used.
- Be sure the on-off switch is off and the LED is not lighted.
- Put the barrel blocking device in its place.
- Make sure the marker is clean.
- Store your ***FREESTYLE*** in a clean, cool, dry place.
- Keep your ***FREESTYLE*** away from unauthorized users.

This is not a toy. Misuse may cause serious injury or death. Eye Protection designed specifically for paintball must be worn by the user and persons within range. Recommend 18 years of age or older to purchase. Persons under 18

years of age must have adult supervision.

Your ***FREESTYLE*** must be clear of all paint and any source of propellant during transportation to and from the playing field. Keep your barrel blocking device in place. Keep the on-off switch in the off position. Protect your ***FREESTYLE*** from excessive heat during transportation. Observe and obey all local, state and federal laws concerning the transportation of paintball markers. For information concerning any of the laws in your area, contact your nearby law enforcement agency.

IMPORTANT: Never carry your ***FREESTYLE*** uncased when not on a playing field. The non-playing public and law enforcement personnel may not be able to distinguish between a paintball marker and firearm. For your own safety and to protect the image of the sport, always carry your ***FREESTYLE*** in a suitable marker case or in the box in which it was shipped.

If you must ship your ***FREESTYLE*** for any reason, the box in which you purchased the marker is acceptable to all major carriers. Never ship charged CO2 or pressurized gas cylinders.

ADJUSTING THE TRIGGER PULL

You will notice three (3) screws in your trigger. These screws adjust the length of pull, actuation point and spring tension of the trigger. The bottom screw adjusts your trigger stop point (length of pull). The middle screw is the contact point for your micro switch or actuation point. The top screw is the spring tension adjustment screw.

1. Use *blue loctite* while adjusting the screws. Normal activity can cause the screws to back out of adjustment. DO NOT glob the loctite on, it can cause damage to the micro switch if you use too much.
2. Begin by adjusting the bottom screw to your desired pull. Screw it in to lessen the distance the trigger must travel.
3. *Very Carefully* screw in the middle screw. Making large adjustments can force the screw into the micro switch and damage it. You will want to screw it in to the point where it makes contact with the micro switch but does not permanently rest on it. Continually check to verify that the LED flashes off and then back on when you pull the trigger. If you pull the trigger and the LED goes off and *stays off*, you have adjusted the screw in too far. Back it out.
4. Adjust the spring tension by turning the top screw in for more tension and out for less tension.
5. Clean up any excess loctite and let it dry for at least an hour before using your ***FREESTYLE***. This ensures the screws will remain in place.

FREESTYLE TUNING GUIDE

Main Input pressure regulator Adjustment:

The ***FREESTYLE*** operates on a proven and innovative system. Take the time to understand this section. The pressurized gas is regulated internally. The high-pressure air is used to propel the paintball. The low-pressure air is used to operate the 3-way solenoid valve located in the rear of the marker. The high-pressure regulator is externally adjustable via the screw on the bottom of the high-pressure regulator (inline regulator). A 5/32 allen key for this screw has been provided to adjust this screw. To increase the pressure, turn the screw clockwise.

NOTE: Only slight turns are needed to accomplish changes in the pressure used to shoot the paintball.

To decrease the pressure shown on the gauge, turn the screw counter-clockwise. You must take a clearing shot before the change in the decreasing direction can be registered.

A pressure gauge has been installed into the regulator body to indicate the exact operating pressure of the marker. This gauge is extremely useful. At the factory we set the regulator gauge to 350-400 PSI with an input pressure of 500 PSI using Compressed air as the base propellant. Under normal circumstances these settings will produce paintball velocities at approximately 280-300 fps. The input pressure from your tank should be set at 550-600 PSI. Higher input pressures will not provide increased performance. There is a specific input side and output side of the main input regulator. If the gauge and input sides are switched, the outcome will be total bypassing of the main input regulator.

Low pressure regulator adjustment (Velocity adjustment):

The low-pressure regulator is externally adjustable via the adjustment screw in the front of the low-pressure regulator. The low-pressure regulator is pre-set at the factory to 85-95 PSI to operate the 3-way solenoid actuated valve located in the rear of the marker. It may be necessary to re-adjust the low-pressure regulator from time to time to achieve desired velocities. Bench adjusting the regulator can be done by pressurizing the marker, be sure the input regulator is set properly, and then turning the adjustment screw inward (clock-wise) until you hear a leak coming from the 3-way valve in the grip area. The 3-way valve has an over-pressurization relief valve that will start to bleed off at approximately 125 PSI, once you hear the leak start then back off the adjustment screw 1/2 turn and the leak will stop. That will approximate the pressure to about 90 PSI. The low-pressure regulator is designed to shut down and preserve the integrity of the low pressure system if it sees an input pressure over approximately 500 PSI coming from the main input regulator.

This marker was designed with safety and safety standards in mind. If you attempt to shoot

paintballs higher than established safety standards, the marker may not function properly.

NOTE 1. If you attempt to operate the marker at extremely high velocities, the internals will not function properly!

NOTE 2. This gun is not designed to shoot above the safety limits established by industry standards but under certain conditions it may. It is therefore important to check the velocity each time before playing with your *FREESTYLE*.

NOTE 3. Higher pressures DO NOT equate into better performance and higher velocities. High pressures in this marker can cause problems, showing up in erratic velocity, extreme gas consumption, leaks, and in general a poor day of play. This marker was designed to perform at lower pressures. If you keep the gauge on the side of the marker set at 350-400 and do the rest of your adjustments with the low-pressure regulator, you will be operating the marker within the range in which it was designed to operate.

TROUBLE SHOOTING GUIDE

Leak related problems

- 1) The ***FREESTYLE*** has a leak down the barrel. Reason: Gas is leaking through or around the valve pin seal or O-ring area.
 - a) Can you hear the leak when the gas is removed? Yes? There is no leak. You hear the ocean.
 - b) The valve seal is marred, scratched, worn out, or dirty. Try cleaning it with rubbing alcohol. If this does not work, replace it.
 - c) Replace the -006 Urethane O-ring around the valve stem.
- 2) The ***FREESTYLE*** has a leak around the low-pressure regulator seam. Reason: the seal between the regulator body and regulator adaptor body is bad, or the regulator is loose.
 - a) Tighten the regulator to the body.
 - b) Replace the -019 O-ring on the low-pressure regulator body.
- 3) The ***FREESTYLE*** has a leak around the high-pressure regulator seam. Reason: the seal between the regulator body and ASA adaptor is bad, or the regulator is loose.
 - a) Tighten the regulator to the adaptor
 - b) Replace the urethane -015 O-ring on the high-pressure regulator body.
- 4) The ***FREESTYLE*** has a leak inside the grip/battery area. Reason: the 3-way valve or internal hose is leaking.
 - a) Check for over-pressurization from the low-pressure regulator. Re-adjust the low-pressure regulator per instructions on the previous pages.

- b) Tighten the 3-way valve to the manifold. Take care not to over-tighten.
- c) Replace the internal hose if it has visible damage.
- d) Replace the solenoid valve assembly. NOTE: NEVER DISASSEMBLE THE SOLENOID VALVE. THIS WILL PERMANENTLY DAMAGE IT BY DISRUPTING THE MAGNETIC FIELD.

Ball Breakage Problems

- 1) The balls break in the breech.
 - a) The balls in you loader can bind, messing up your trigger timing. Always use an agitated loader and verify the PDS is on.
 - b) If the ball retention ball does not move freely, the paintballs will crush against it or it may have stuck in the depressed position, allowing double feeding. Check its tension regularly and keep this area as clean as possible.
 - c) If the ball retention is too sloppy, the ball will not be held in the proper position. This may allow the next ball to enter the path of the bolt, subjecting it to impact cracking or shearing. Verify the tension.

Regulator Related Problems

- 1) The gauge reads correctly when charged, but climbs in pressure after a few moments.
Reason: The regulator seal has been contaminated.
 - a) Disassemble the regulator and clean the seal with a Q-tip and alcohol. If you need assistance in the disassembly of the regulator, please call (208) 468-0446.
- 2) The gauge reads correctly when charged, but drops in pressure after a few shots.
 - a) The regulator may not be adjusted correctly. Remove all pressurized gas and back out the regulator adjustment screw until it is flush with the body. Pressurize the system and adjust the pressure back up to the desired pressure.
 - b) Verify that the on/off valve on your bottom line adaptor is properly adjusted. If the valve is only partially open, it will restrict air flow into the regulator.
- 3) The gauge reads correctly when charged, but drops in pressure after a few shots, and is slow to climb back to normal pressure.
 - a) The recovery side of the regulator is sluggish and may need cleaning and lubrication. Clean out any debris and lubricate the urethane O-ring on the outside of the delrin plunger. If you need assistance in the disassembly of the regulator, please call (208) 468-0446.
 - b) The regulator seal needs to be replaced if it has a deep groove in it from the regulator cup.

Replacing or removing the original regulators voids all warranties.

Battery Related Problems

- 1) LED Functions but the marker does not fire.
- 2) Alternately missed shots.
- 3) Velocity drops while firing several shots.
- 4) Erratic velocities. Jumps of 20 fps or more.
- 5) Unexplainable paint breakage.
- 6) Slight leak from the solenoid in the back of the grip.

Change the Battery. The LED only requires 1.5 volts to function. The solenoid requires a minimum of 5 volts to operate. This means the marker may appear to be getting enough power when it is not. All batteries are NOT created equal. Performance will vary. **Therefore, if you experience any erratic behavior, always change the battery first.**

NOTES:



Tools You will Need:

Clear Lithium Grease

SuperLube with PTFE (visit www.super-lube.com for more information)

Small phillips screwdriver

5/64 Hex Key

3/32 hex Key

7/64 Hex Key

1/8 Hex Key

5/32 Hex Key

Thread Tape



Replacing the Battery:

- 1. Work on the left hand side of the marker, as shown above.**
- 2. Remove the two 6-32 screws holding the rubber grip panel in place.**
- 3. Move the rubber grip panel out of the way by sliding underneath the trigger guard.**
- 4. Replace the battery and reinstall inside the grip, being careful not to pinch or tear any wires.**
- 5. Reinstall the rubber grip panel.**

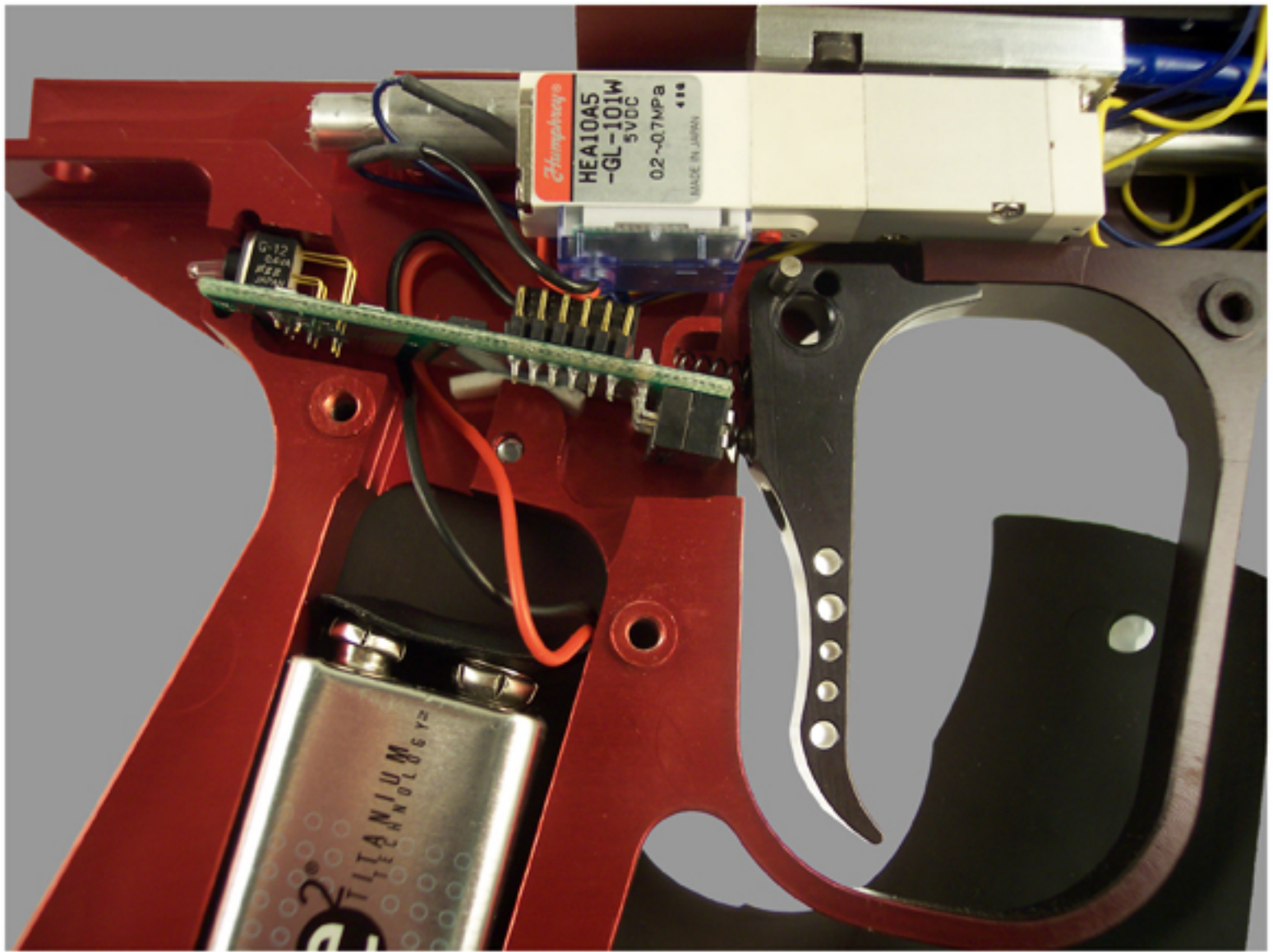

Accessing the Electronics and Trigger:

- 1. Work on the right hand side of the marker, as shown above.**
- 2. Remove the two 6-32 screws holding the rubber grip panel in place.**
- 3. Move the rubber grip panel out of the way by sliding underneath the trigger guard.**
- 4. Remove the four 6-32x1/4 SHCS that hold the right clamshell grip in place.**
- 5. Carefully remove the clamshell. You now have access to the electronics and trigger.**
- 6. Reinstall the clamshell grip and rubber grip panel.**



To Field-Strip the marker:

- 1. De-pressurize the marker.**
- 2. Uncscrew the 10-32 screw from underneath the rear manifold.**
- 3. Slide the cylinder assembly out through the back of the marker.**
- 4. The entire breech is now open for cleaning.**

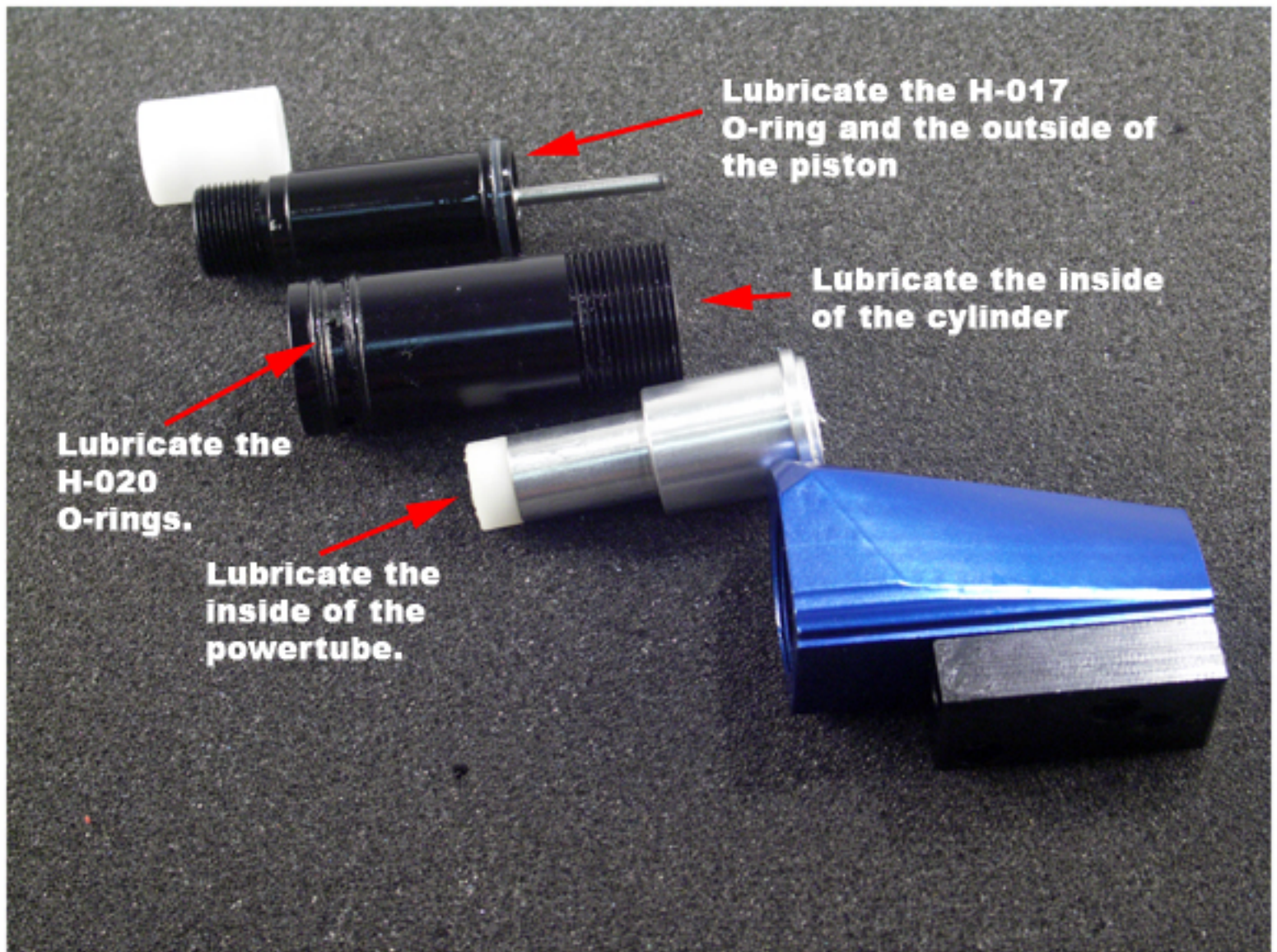

To Lubricate the Cylinder Assembly:

- 1. Begin by unscrewing the cylinder from the powertube.**
- 2. Unscrew the bolt tip from the piston.**
- 3. Each piece is now available for cleaning and lubrication as shown above.**
- 4. Clean each piece carefully with a clean, dry rag.**
- 5. Lubricate all of the o-rings and the marked surfaces. Do not over lubricate! SuperLube is the recommended lubricant but synthetic oil with PTFE may be substituted. DO NOT USE GREASE ON THE CYLINDER! NEVER USE PETROLEUM PRODUCTS!!!**
- 6. Reassemble the cylinder and screw onto the powertube.**
- 7. Repeat this process frequently.**

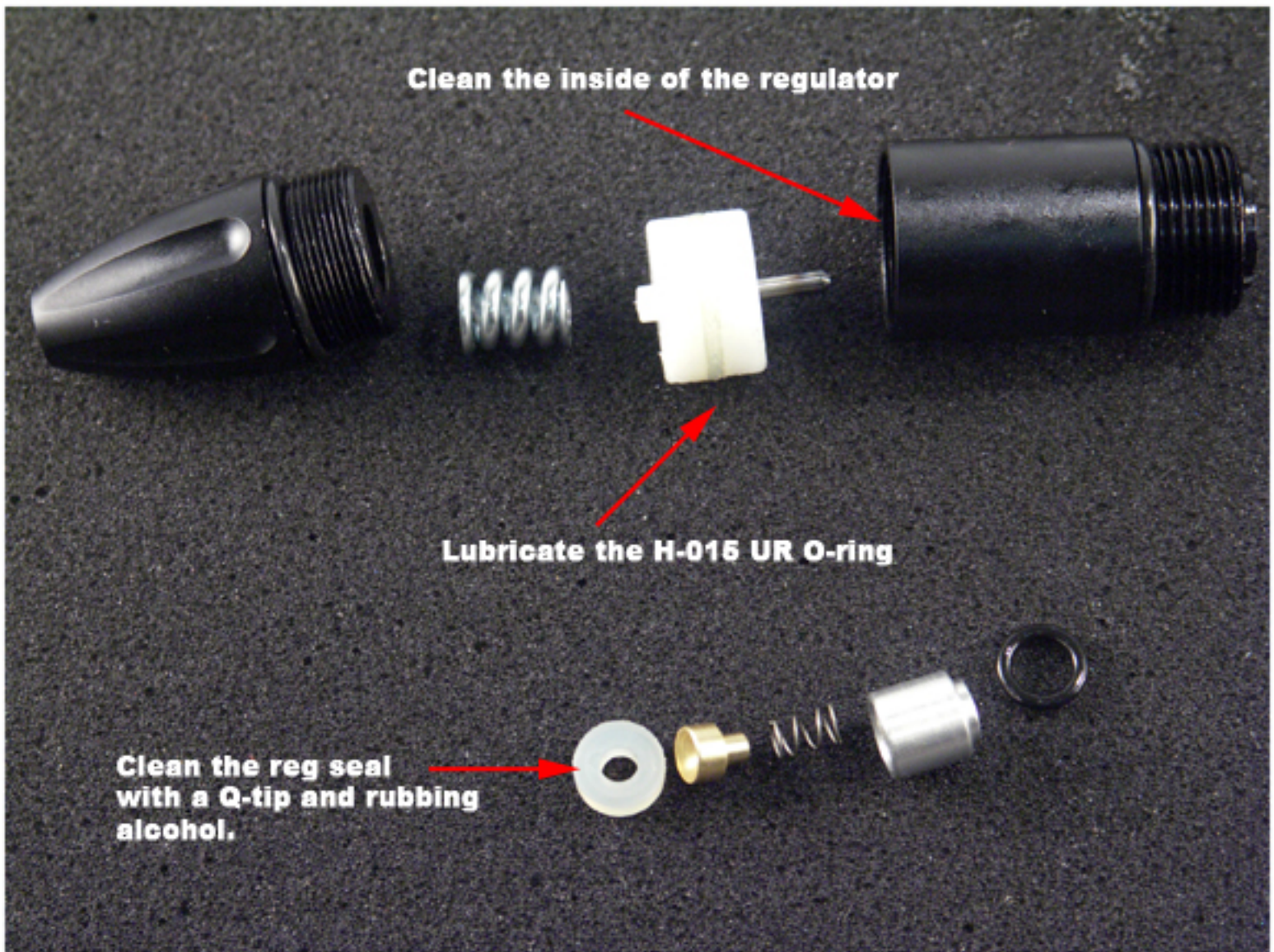

Maintaining Your Regulators:

- 1. Disassemble the LP Regulator. Do not lose any pieces, the regulator will not function without them.**
- 2. Clean all of the pieces with a rag. It is especially important to clean the inside of the regulator.**
- 3. Clean the reg seal with a Q-Tip and rubbing alcohol. Flip it over if there is a deep groove from the regulator cup.**
- 4. Lubricate the H-015 UR O-ring on the regulator piston.**
- 5. Reassemble the regulator.**
- 6. Repeat on the HP Regulator.**
- 7. Maintain your regulators frequently.**

Remember, you will need to readjust your pressures after disassembly!!

Cleaning the ball detents:



1. Remove the eye cover by unscrewing the 4-40x1/4 SHCS.



2. Clean the ball detent with water and dry thoroughly. Clean the area around the ball detent if needed. Do not lose the small spring.

3. Reassemble and repeat on the other side. Make sure you do not pinch any wires while reassembling.

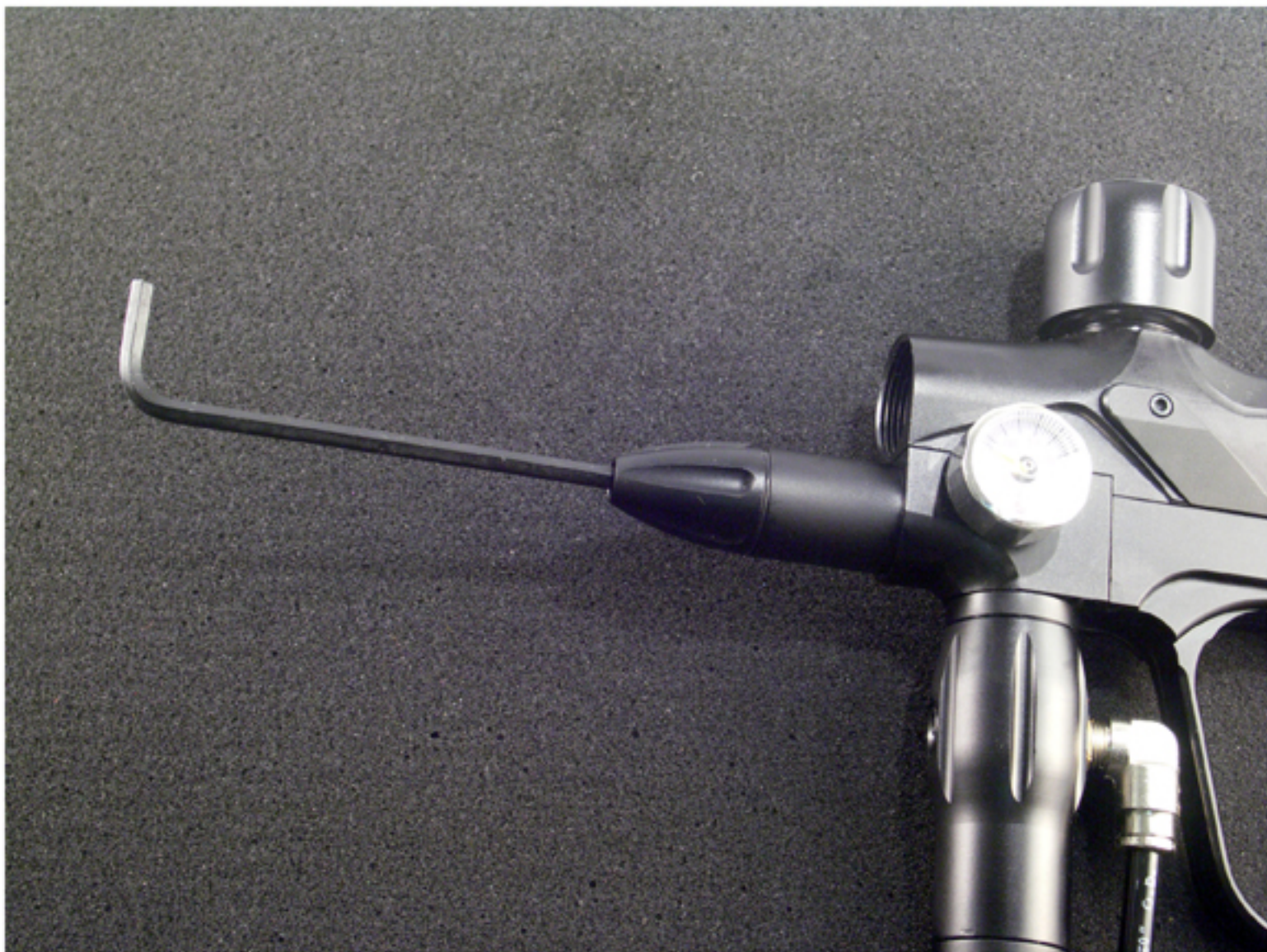

Adjusting the Low Pressure Regulator:

Understanding your regulators: The high pressure regulator controls the gas that is used to fire the paintball. The low pressure regulator controls the gas that holds the bolt back. However, the low pressure regulator will still affect velocity because the bolt has to overcome the force of the air. Refer to the instruction video for more information.

- 1. Verify that the High Pressure regulator is adjusted to 320-380 PSI. The best starting place is 350 PSI.**
- 2. Slowly screw in the LP Regulator adjustment screw until the bolt clears the breech.**
- 3. Begin by dry-firing the marker and adjust the LP regulator further until the bolt is very responsive and makes a snappy sound. Screw in an additional 1/4-1/2 turn.**
- 3. Chronograph the marker. If it is not chronographing at the right velocity, fine-tune the HP Regulator with small adjustments either higher or lower to achieve velocity. Do not exceed 400 PSI on the HP regulator.**



To Adjust the High Pressure Regulator:

Understanding your regulators: The high pressure regulator controls the gas that is used to fire the paintball. The low pressure regulator controls the gas that holds the bolt back. However, cranking the high pressure regulator all the way in does not equate with better performance. The most important aspect of optimal performance is a balance between the high and low pressures so that gas is used efficiently.

- 1. Slowly screw in the HP regulator adjustment screw until the the gauge reads between 320-380 PSI. It is best to start around 350 PSI.**
- 2. You turn the wrench clockwise to raise the pressure. Do not exceed 400 PSI.**
- 3. You turn the wrench counter-clockwise and shoot to clear to lower the pressure.**
- 4. After the HP Regulator has been set, follow the directions for adjusting the LP Regulator.**
- 5. Fine-Tune the HP regulator for velocity after the LP Regulator has been set.**

2005 FreeStyle Schematic

Part 1 of 2

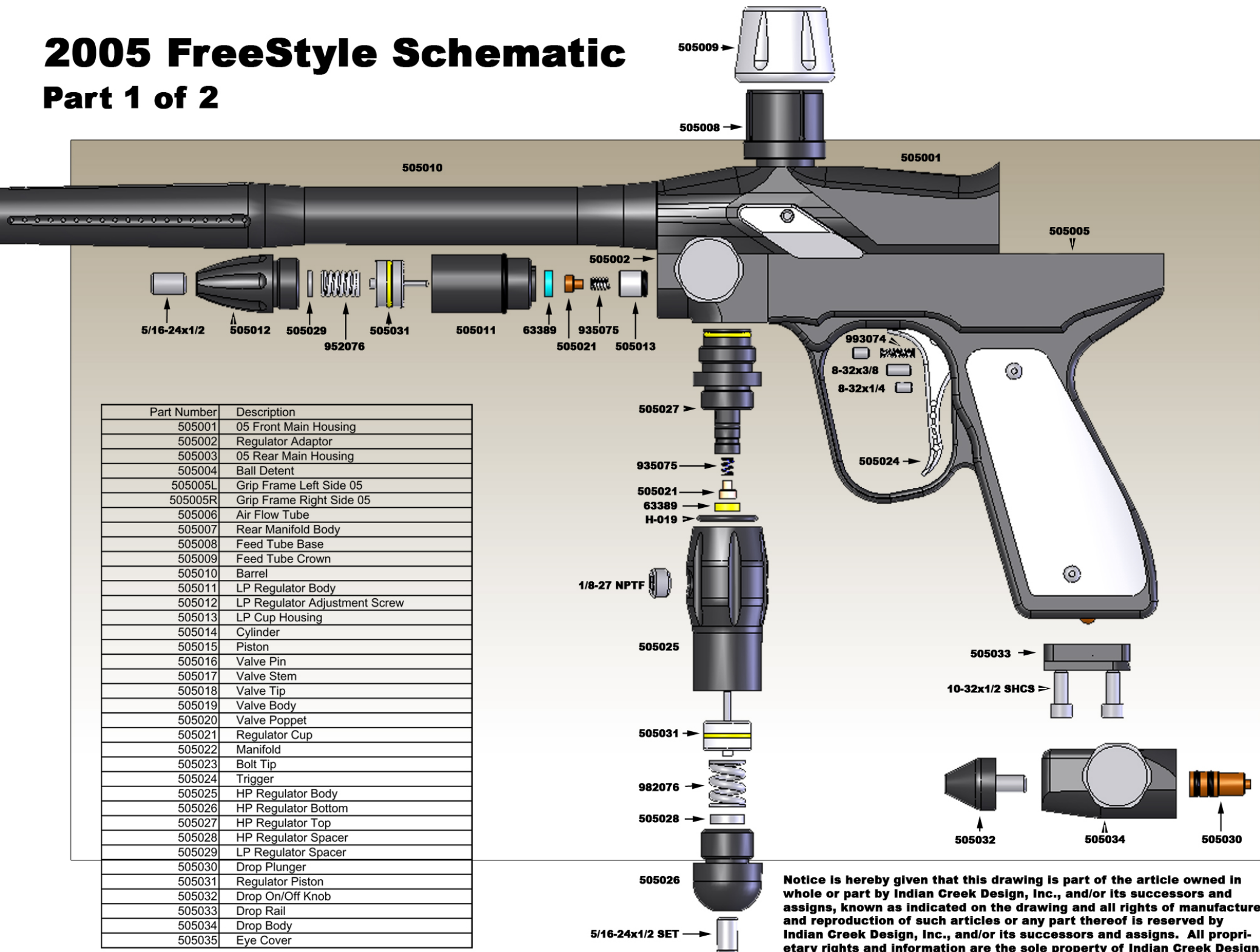

Notice is hereby given that this drawing is part of the article owned in whole or part by Indian Creek Design, Inc., and/or its successors and assigns, known as indicated on the drawing and all rights of manufacture and reproduction of such articles or any part thereof is reserved by Indian Creek Design, Inc., and/or its successors and assigns. All proprietary rights and information are the sole property of Indian Creek Design, Inc., and/or its successors and assigns.

2005 FreeStyle Schematic

Part 2 of 2

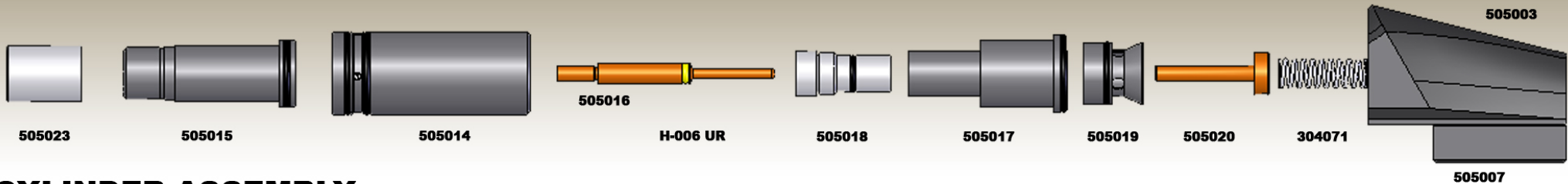

CYLINDER ASSEMBLY

Part Number	Description
505001	05 Front Main Housing
505002	Regulator Adaptor
505003	05 Rear Main Housing
505004	Ball Detent
505005L	Grip Frame Left Side 05
505005R	Grip Frame Right Side 05
505006	Air Flow Tube
505007	Rear Manifold Body
505008	Feed Tube Base
505009	Feed Tube Crown
505010	Barrel
505011	LP Regulator Body
505012	LP Regulator Adjustment Screw
505013	LP Cup Housing
505014	Cylinder
505015	Piston
505016	Valve Pin
505017	Valve Stem
505018	Valve Tip
505019	Valve Body
505020	Valve Poppet
505021	Regulator Cup
505022	Manifold
505023	Bolt Tip
505024	Trigger
505025	HP Regulator Body
505026	HP Regulator Bottom
505027	HP Regulator Top
505028	HP Regulator Spacer
505029	LP Regulator Spacer
505030	Drop Plunger
505031	Regulator Piston
505032	Drop On/Off Knob
505033	Drop Rail
505034	Drop Body
505035	Eye Cover

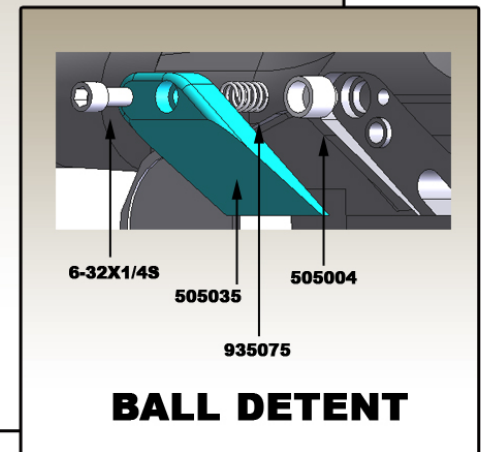
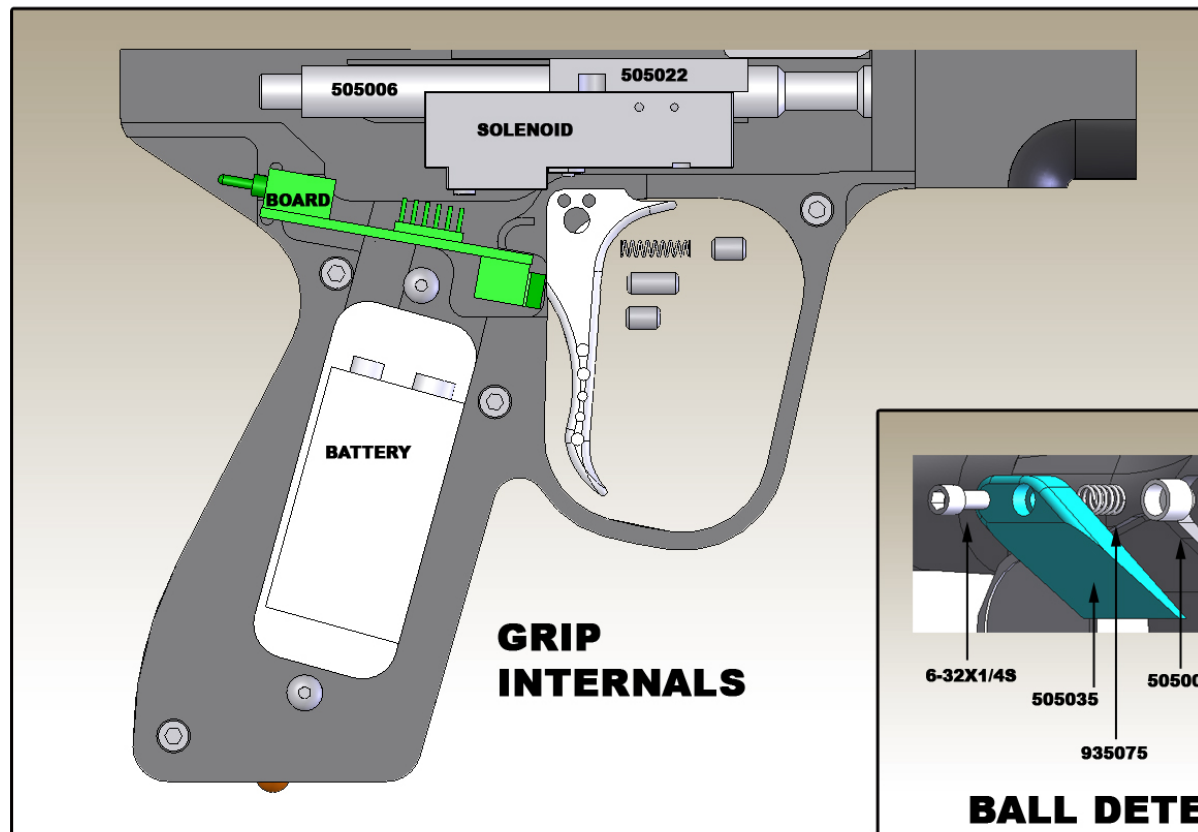

Notice is hereby given that this drawing is part of the article owned in whole or part by Indian Creek Design, Inc., and/or its successors and assigns, known as indicated on the drawing and all rights of manufacture and reproduction of such articles or any part thereof is reserved by Indian Creek Design, Inc., and/or its successors and assigns. All proprietary rights and information are the sole property of Indian Creek Design, Inc., and/or its successors and assigns.