

BACK COVER BLANK

- Owner's Manual
- Manual del Usuario

**PROJECT SALVO™**



PLAY..  
SMART..  
PLAY..  
STRONG..  
ARMY..  
STRONG™

**PROJECT  
SALVO™**



**WARNING**

THIS IS NOT A TOY. MISUSE MAY CAUSE SERIOUS INJURY OR DEATH. EYE, FACE AND EAR PROTECTION DESIGNED FOR PAINTBALL MUST BE WORN BY THE USER AND ANY PERSON WITHIN RANGE. WE RECOMMEND AT LEAST 18 YEARS OLD TO PURCHASE. PERSONS UNDER 18 MUST HAVE ADULT SUPERVISION WHEN USING THIS PRODUCT. READ THE OWNER'S MANUAL BEFORE USING THIS PRODUCT.

**ADVERTENCIA**

ESTO NO ES UN JUGUETE. UN USO INAPROPIADO PUEDE CAUSAR SERIAS HERIDAS O LA MUERTE. OJOS, CARA Y OIDOS DEBEN ESTAR PROTEGIDOS TODO EL TIEMPO, CON LA PROTECCIÓN DISEÑADA PARA PAINTBALL TANTO PARA JUGADORES COMO PARA CUALQUIER PERSONA QUE ESTE EN EL RADIO DE ALCANCE. RECOMENDAMOS AL MENOS 18 AÑOS DE EDAD PARA LA COMPRA Y USO. LAS PERSONAS MENORES DE 18 AÑOS DEBEN USAR ESTE PRODUCTO BAJO LA SUPERVISIÓN DE UN ADULTO. ANTES DE USAR ESTE PRODUCTO LEA EL MANUAL DEL USUARIO.

**WARNING**

SAFETY IS YOUR RESPONSIBILITY

READ, FAMILIARIZE YOURSELF AND ANY OTHER USER OF THIS MARKER WITH THE SAFETY INSTRUCTIONS IN THIS MANUAL. FOLLOW THESE INSTRUCTIONS WHEN USING, WORKING ON, TRANSPORTING OR STORING THIS MARKER.



ALWAYS KEEP TRIGGER SAFETY IN SAFE MODE UNLESS FIRING AS DETAILED IN INSTRUCTIONS ON PAGE 4.



ALWAYS KEEP THE BARREL BLOCKING DEVICE INSTALLED WHEN NOT IN SHOOTING SITUATION, SEE INSTRUCTIONS ON PAGE 2.

**ADVERTENCIA**

LA SEGURIDAD ES SU RESPONSABILIDAD

EL PROPIETARIO Y TODA PERSONA QUE UTILICE ESTE MARCADOR DEBE LEER Y FAMILIARIZARSE CON LAS INSTRUCCIONES DE SEGURIDAD EN ESTE MANUAL. SIGA LAS INSTRUCCIONES DE USO, MANTENIMIENTO, TRANSPORTE Y ALMACENAJE DE ESTE MARCADOR.



MANTENGA SIEMPRE EL SEGURO DEL GATILLO ACTIVADO A MENOS QUE SEA NECESARIO HACER DISPAROS. COMO SE VE EN LAS INSTRUCCIONES DE LA PÁGINA 3.



MANTENGA EL MECANISMO DE BLOQUEO DEL BARRIL INSTALADO CUANDO NO ESTE HACIENDO DISPAROS COMO SE ILUSTRÁ EN LA PÁGINA 1.

# PROJECT SALVO™

2955 Adams Center Road, Fort Wayne, IN 46803 USA  
 P) 260-749-6022 • F) 260-749-6619 • www.tippmann.com

CONGRATULATIONS on your purchase of a U.S. ARMY Project Salvo™ paintball marker. We believe our Project Salvo™ markers to be the most accurate and durable paintball markers available, and are proudly manufactured by Tippmann®. All Project Salvo™ markers will provide many years of dependable service if cared for properly. Visit [www.usarmypaintball.com](http://www.usarmypaintball.com) and find out how to maximize your paintball experience – play smart... play strong...Army Strong™.

Please take time to read this manual thoroughly and become familiar with your Project Salvo™ marker's parts, operation, and safety precautions before you attempt to load or fire this marker. If you have a missing or broken part or need assistance, please contact Tippmann Consumer Relations at 1-800-533-4831 for fast friendly service.

## TABLE OF CONTENTS

Warning/Caution .....	2
Warning/Caution Barrel Blocking Device Installation .....	2
Warning/Liability Statement .....	4
Safety is your Responsibility / Familiarize Yourself With Safety .....	4
Safe Mode = Turning The Safety On (PUSH SAFE) .....	4
Fire Mode = Turning The Safety Off (PUSH FIRE) .....	4
Getting Started .....	6
1. Prepare Marker for Air Supply Cylinder Installation .....	6
2. Air Supply Cylinder Installation .....	7
3. Hopper Installation .....	8
4. Velocity Adjustment .....	8
Specifications .....	9
Schematics .....	10
Unloading Your Marker .....	12
Air Supply Cylinder Removal / Air or CO <sub>2</sub> Cylinder Safety Tips .....	12
Repairing Air Supply Leaks .....	15
Cleaning & Maintenance .....	15
Storage .....	15
Marker Disassembly / Assembly .....	16
Warranty Information, Registration and Repairs .....	20



## WARNING

**THIS IS NOT A TOY. MISUSE MAY CAUSE SERIOUS INJURY OR DEATH. EYE, FACE AND EAR PROTECTION DESIGNED FOR PAINTBALL MUST BE WORN BY THE USER AND ANY PERSON WITHIN RANGE. WE RECOMMEND AT LEAST 18 YEARS OLD TO PURCHASE. PERSONS UNDER 18 MUST HAVE ADULT SUPERVISION WHEN USING THIS PRODUCT. READ THE OWNER'S MANUAL BEFORE USING THIS PRODUCT.**



## WARNING

**KEEP THE BARREL BLOCKING DEVICE INSTALLED EXCEPT WHEN YOUR MARKER IS IN USE. ALWAYS MAKE SURE THAT THE TRIGGER SAFETY IS IN THE SAFE MODE (SEE INSTRUCTIONS ON PAGE 4) AND THE BARREL BLOCKING DEVICE IS PROPERLY INSTALLED ON YOUR MARKER ACCORDING TO THE INSTRUCTIONS TO PREVENT DAMAGE TO PROPERTY, SERIOUS INJURY OR DEATH.**

### BARREL BLOCKING DEVICE INSTALLATION INSTRUCTIONS

1) Insert the barrel blocking device ⇨ into the barrel (or over the barrel, depending on the style of barrel blocking device) and loop the cord over the top of the receiver and position at the back of the grip as shown.



2) Adjust the cord length retainer up to the back of the grip by pulling the cord through it until the retainer is snug against the back of the grip. Keeping the cord as tight as possible, leave just enough cord elasticity to pull the cord/retainer up over the top of the marker to remove the barrel blocking device for firing.

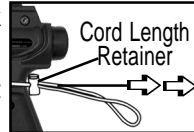

3) After the cord length is properly adjusted, lock the cord length by tying a knot in the cord against the back of the retainer as shown.



4) Before and after playing, inspect the barrel blocking device and replace if bag, plug, or cord damage, or loss of cord elasticity is found.

5) Clean the barrel blocking device with plain, warm water and store out of sunlight in a dry area when not in use.

## Warning/Liability Statement

This marker is classified as a dangerous weapon and is surrendered by Tippmann Sports, LLC with the understanding that the purchaser assumes all liability resulting from unsafe handling or any action that constitutes a violation of any applicable laws or regulations. Tippmann Sports, LLC shall not be liable for personal injury, loss of property or life resulting from the use of this weapon under any circumstances, including intentional, reckless, negligent or accidental discharges.

All information contained in this manual is subject to change without notice. Tippmann Sports, LLC reserves the right to make changes and improvements to products without incurring any obligation to incorporate such improvements into products previously sold.

If you as a user do not accept liability, Tippmann Sports, LLC requests you do not use a Tippmann Sports, LLC marker. By using this paintball marker you release Tippmann Sports, LLC of any and all liability associated with its use.

## SAFETY IS YOUR RESPONSIBILITY!

### WARNING

**TRIGGER SAFETY ACTIVATION**

- **EXCEPT WHEN YOUR MARKER IS IN USE, ALWAYS MAKE SURE THAT THE TRIGGER SAFETY IS IN SAFE MODE, WHICH DISABLES THE TRIGGER, AND THE BARREL BLOCKING DEVICE IS INSTALLED (SEE PAGE 2).**
- **TO TURN ON THE SAFETY (SAFE MODE): PUSH THE SAFETY IN AS SHOWN ABOVE.**
- **TO TURN SAFETY OFF (FIRE MODE): PUSH SAME BUTTON ON OPPOSITE SIDE OF RECEIVER.**

## FAMILIARIZE YOURSELF WITH SAFETY...

The ownership of this weapon places upon you the total responsibility for its safe and lawful use. You must observe the same safety precautions as you would any firearm to assure the safety of not only yourself but everyone around you. The user should at all times use caution when using this marker. The sport of Paintball will be viewed and judged upon your safe and sportsmanlike conduct. Always

remember that the game of Paintball can only survive and grow if it remains SAFE!

- Do not load or fire this marker until you have completely read this manual and are familiar with its safety features, mechanical operation and handling characteristics.
- Handle this and any marker as if it were loaded at all times.
- Keep your finger off the trigger until ready to shoot.
- Do not look down the barrel of a paintball marker. Accidental discharge into the eyes may cause permanent injury or death.
- Keep the trigger safety in safe mode until ready to shoot (see page 4).
- Keep the barrel blocking device installed on marker when not shooting (see page 2).
- Never point the marker at anything you do not intend to shoot.
- Never fire your marker at anything you do not intend to shoot because there may be balls or foreign debris lodged in the chamber, barrel and / or the marker valve.
- Do not shoot at fragile objects such as windows.
- Never fire your marker at personal property of others. The paintball impact can cause damage and the paint can stain the finish of automobiles, houses etc.
- Always keep the muzzle pointed down or in a safe direction, even if you stumble or fall.
- Eye, face and ear protection designed specifically to stop paintballs in the form of goggles and full face mask meeting ASTM Specification F 1776 must be worn by the user and any person within range.
- Never shoot at a person who is not protected by eye, face and ear protection designed for paintball.
- Pressurize and load the marker only when the marker will be immediately used.
- NOTE: Before storing or disassembling be sure to remove paintballs and air supply (see unloading and air supply removal instructions on page 16), put the trigger safety in the safe mode (see page 4) and install the barrel blocking device (see page 2).
- Store the marker unloaded and degassed in a secure place.
- Do not field strip or otherwise disassemble this marker while it is pressurized with air supply.
- Dress appropriately when playing the game of paintball. Avoid exposing any skin when playing the game of paintball. Even a light

layer will absorb some of the impact and protect you from the paintballs.

- Keep exposed skin away from escaping gas when installing or removing air supply cylinder or if the marker or air supply is leaking. Compressed air, CO<sub>2</sub>, and nitrogen gasses are very cold and can cause frostbite under certain conditions.
- Use only .68 caliber paintballs, never load or fire any foreign objects.
- Avoid alcoholic beverages before and during the use of this marker. Handling markers while under the influence of drugs or alcohol is a criminal disregard for public safety.
- Avoid shooting an opponent at point blank, 6 feet or less.
- Familiarize yourself with instructions listed on air supply cylinder or adaptor. Contact the air supply cylinder or adaptor manufacturer with any questions.
- Read the Air Supply Cylinder Removal and SAFETY TIPS on pages 12-14 before beginning the cylinder installation.
- Always measure your marker's velocity before playing paintball and never shoot at velocities in excess of 300 feet per second (see instructions on page 8).

## GETTING STARTED

□ Eye protection designed for paintball use must be worn by the user and any person within range. Do not disassemble this marker while it is pressurized with air. Do not pressurize a partially assembled marker.

**Read each step completely before performing the step.**

Carefully hand start all threaded parts and do not overtighten and strip threaded parts when assembling.

### STEP 1: Prepare Marker for Air Supply Cylinder Installation

1) □ Install the shroud (14) before you install the barrel (9). To install the shroud: □ Remove receiver bolt (5) and □ insert the shroud. □ Replace and tighten the bolt (5) to hold the shroud in place.

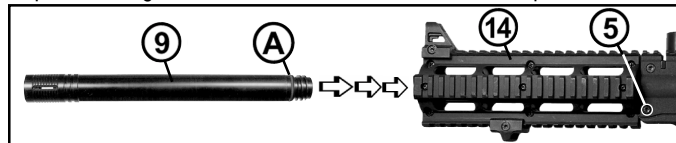

2) □ Install the barrel (with the shroud installed): □ apply marker oil onto the barrel o-ring (A), insert the barrel into the shroud / receiver and carefully screw it in C.

□ Install the collapsible stock. □ With the end cap cover (T) removed (slides off), □ Slide stock up (C) into end cap. □ Insert bolt (D) and carefully tighten C.

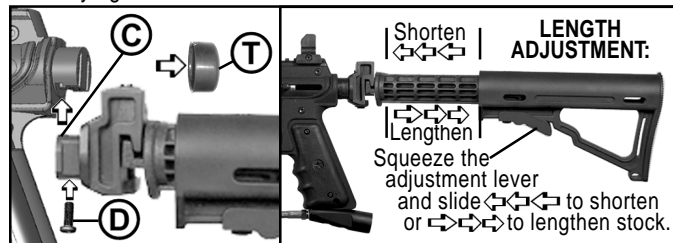

### TO FOLD THE STOCK / TO UNFOLD THE STOCK:

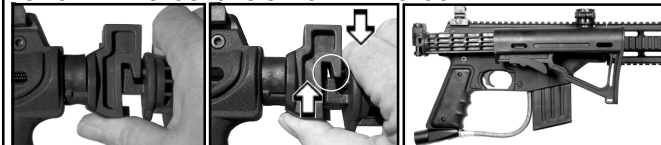

- 1) Grip the stock with thumb under the hinge/latch as shown.
- 2) Squeeze until the latch opens.
- 3) Turn stock to right side of receiver and release.
- 4) To unfold: grip the stock with thumb under the hinge/latch. Squeeze to open latch, turn to unfolded position and release the latch to lock in place.

## STEP 2: Air Supply Cylinder Installation

□ You must first read the Air Supply Cylinder Removal and SAFETY TIPS on pages 12-14 before beginning the cylinder installation.

- Do not pressurize a partially assembled paintball marker.
- First put the trigger safety in Safe Mode (see instructions on page 4) and □ install the barrel blocking device (see instructions on page 2).
- Next you need to cock the marker by sliding the bolt handle all the way back until it locks into place (1). Always keep marker in the cocked position when air supply is attached to the marker. This will help prevent an accidental discharge.

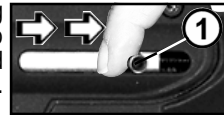

□ To install the air supply cylinder, lubricate the cylinder valve o-ring with a little marker oil then insert the cylinder valve end into the air supply adapter at the back end of the marker grip. Twist the cylinder

**Air Supply Cylinder Installation:** (continued from page 7)



clockwise  into the marker until it stops. Your marker is ready to fire once you switch to Fire Mode from Safe Mode (see instructions on page 2). If the tank is full and you do not hear the air supply engage, the pin valve could be too short or the pin valve seal is damaged, follow the Air Supply Cylinder Removal instructions on pages 12-14 and take your air or CO<sub>2</sub> cylinder to a "C5" Certified Airsmith for inspection or contact the cylinder manufacturer).

### STEP 3: Hopper Installation

- ❑ The barrel blocking device must be installed (see page 2) and the trigger safety in Safe Mode (see page 4) before filling the hopper.
- ❑ Make sure that the feed elbow and hopper are clean and free of any sharp edges to keep paintballs feeding into the marker smoothly.
- ❑ Install the hopper neck into the feed elbow of your marker and tighten the hopper down with a 3/16" allen wrench  included with your marker. NOTE: Do not overtighten or the elbow may break.
- ❑ With the trigger safety in Safe Mode and the barrel blocking device installed, you are now ready to load your hopper with paintballs. Fill the hopper and only remove the barrel blocking device and turn off the trigger safety when ready to shoot.

### STEP 4: Velocity Adjustment

Each time you play paintball, the velocity of your paintball marker should be checked with a chronograph, an instrument for measuring velocity, prior to playing paintball to verify that the marker's velocity is set below 300 feet per second or less if required by playing field.

To adjust the velocity use the 3/16" allen wrench  included with your marker. The velocity adjustment screw is located on left side receiver. To reduce the velocity, turn the screw inward or clockwise . To increase the velocity, turn the screw counterclockwise . Do not remove the velocity screw.

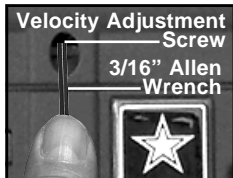

## Specifications: PROJECT SALVO™ Marker

<b>Model</b> .....	<b>Project Salvo™</b>
Caliber .....	.68
Action .....	Semi-Automatic (open bolt blow-back)
Power/Air Supply .....	compressed air, nitrogen or CO <sub>2</sub>
Hopper Capacity .....	200 Paintballs
Ball Feed .....	Gravity
Cycle Rate .....	8 shots per second
Standard Barrel Length .....	11" / 28 cm
Overall Length (with standard barrel & no tank) .....	28.63 - 32.5" / 72.71 - 82.55 cm
Weight (without tank) .....	3.8 lbs. / 1.72 kg
Effective Range .....	150+ ft. / 46+ metres
Velocity .....	Always measure your marker's velocity before playing paintball and never shoot at velocities in excess of 300 feet per second (see instructions on page 8).



# PROJECT SALVO™

## Basic Parts List

ENGLISH

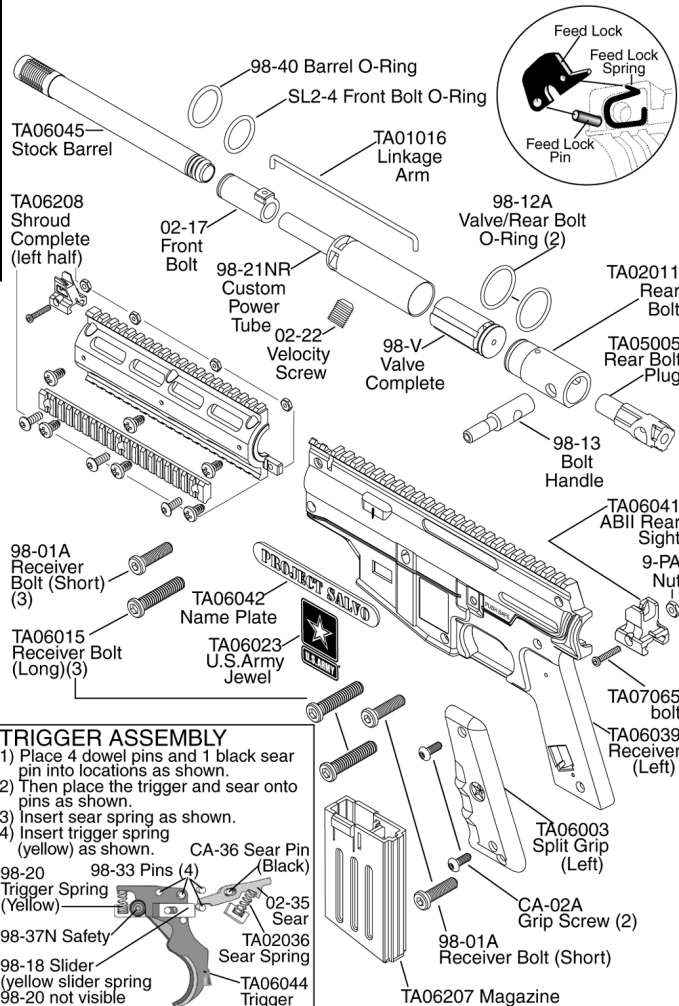

**WARNING**  
DO NOT DISASSEMBLE THIS MARKER WHILE IT IS PRESSURIZED WITH AIR. DO NOT PRESSURIZE A PARTIALLY ASSEMBLED MARKER.

ENGLISH

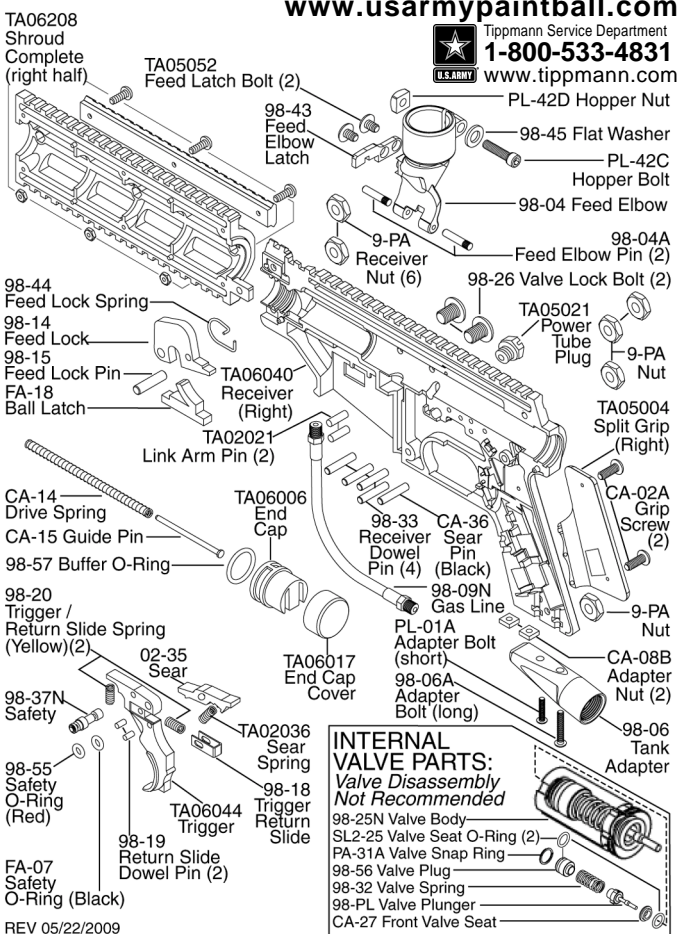

[www.usarmypaintball.com](http://www.usarmypaintball.com)  
Tippmann Service Department  
**1-800-533-4831**  
[www.tippmann.com](http://www.tippmann.com)

## Unloading Your Marker

To unload your marker:  Eye protection designed for paintball use must be worn by the user and any person within range.

- Put the trigger safety in Safe Mode (see instructions on page 4) and  install the barrel blocking device (see page 2).
- Empty and remove the hopper, loosen  the hopper bolt and pull the hopper out (at reassembly, do not overtighten bolt or the elbow may break).
- Go to a designated firing area and remove the barrel blocking device.
- Point your marker in a safe direction and fire several times to be sure there are no balls lodged in the chamber and / or barrel. **IMPORTANT:** Do not uncock your marker as uncocking your marker may push a ball into the chamber or down into the barrel in which case the ball will be hidden from view.
- Put the trigger safety in Safe Mode (see instructions on page 4) and  install the barrel blocking device (see page 2).
- Visually inspect the chamber for paintballs.

## Air Supply Cylinder Removal

**Step 1)**  You must first read the following Air Supply Cylinder WARNINGS and SAFETY TIPS ( before beginning the cylinder removal in Step 2 on page 14).



### WARNING

**NEVER UNSCREW ⑤ THE CYLINDER ② FROM THE CYLINDER VALVE ①.**

THE BRASS OR NICKEL PLATED VALVE ① IS INTENDED TO BE PERMANENTLY ATTACHED TO THE AIR OR CO2 CYLINDER ②. AN AIR OR CO2 CYLINDER CAN FLY OFF WITH ENOUGH FORCE TO CAUSE SERIOUS INJURY OR DEATH IF THE CYLINDER ② UNSCREWS ⑤ FROM A CYLINDER VALVE ①.

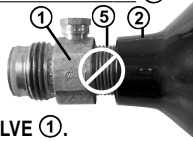

There have been reported incidents that were caused by players unknowingly unscrewing the cylinder ② from the cylinder valve ①. This occurs when the player thinks the entire valve-cylinder assembly is being unscrewed from the air adaptor of the paintball marker (H) when in fact they are unscrewing the cylinder ② from the cylinder valve ①. **To Avoid This Danger:** It is recommended, if your cylinder is not already marked, that you use paint or nail polish to  place a mark ③ on the cylinder valve and  place a mark ④ on the cylinder as shown.

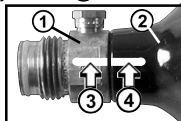

Whenever you turn the cylinder ② during removal,  watch the mark ④ on the cylinder and the mark ③ on the cylinder valve to be

Air Supply Cylinder Removal: (continued from page 12)

sure that they rotate together. If at any time these marks start to separate as shown ⑤, the cylinder ② is starting to unscrew from the cylinder valve ① and you should STOP and take the entire unit to a "C5" certified airsmith for safe removal and/or repair.

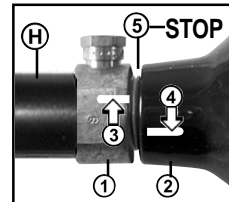

**NOTE:** The cylinder valve should unscrew from the paintball marker in about 3 or 4 full turns. If you finish the 4th full turn and the cylinder valve is not unscrewed from the paintball marker, STOP! Take the entire unit to a "C5" certified airsmith for safe removal and/or repair.  Locate a "C5" Certified Airsmith at [www.paintball-pti.com/search.asp](http://www.paintball-pti.com/search.asp)

Whether you have a new or used refillable Air or CO2 cylinder, you are at risk if any of the following has occurred:  The valve unit was replaced or altered after purchase.  An anti-siphon device was installed.  The valve unit was removed from the cylinder for any reason.  Any modification was done to the refillable Air or CO2 cylinder. If any of these conditions has occurred take your air or CO2 cylinder to a "C5" Certified Airsmith for inspection or contact the cylinder manufacturer.

**SAFETY TIPS** to ensure that your Air or CO2 cylinder is safe for play:

- Improper use, filling, storage or disposal of Air or CO2 cylinder may result in property damage, serious personal injury or death.
- Make sure that any maintenance or modification to any Air or CO2 cylinder is done by a qualified professional, such as a "C5" certified airsmith.
- The use of anti-siphon devices is not recommended. However, if one is already installed on your Air or CO2 cylinder or is desired, it is critical that your cylinder be checked by, or the device installed by, a qualified professional.
- All Air or CO2 cylinders must be filled only by properly trained personnel.
- Cylinder valves must be installed only by properly trained personnel.
- Do not overfill!!! Never exceed the Air or CO2 cylinder's capacity.
- Do not expose pressurized Air or CO2 cylinder to temperatures exceeding 130 degrees Fahrenheit ( 55 degrees Celsius ).
- Do not use caustic cleaners or strippers on the Air or CO2 cylinder or tank valve and do not expose to corrosive materials.
- Do not modify the Air or CO2 cylinder in any way. Never try to disassemble the tank valve from the Air or CO2 cylinder.



**Air Supply Cylinder Removal:** (continued from page 13)



- Any Air or CO<sub>2</sub> cylinder that has been exposed to fire or heated to a temperature of 250 degrees Fahrenheit ( 121 degrees Celsius ) or more must be destroyed by properly trained personnel.
- Use appropriate gas for your cylinder. Only use CO<sub>2</sub> in a CO<sub>2</sub> cylinder and only use compressed air in a compressed air cylinder.
- Keep all cylinders out of the reach of children.
- The Air or CO<sub>2</sub> cylinder should be inspected and hydrostatically retested at least every 5 years by a DOT licensed agency.
- Locate a "C5" Certified Airmith at [www.paintball-pti.com/search.asp](http://www.paintball-pti.com/search.asp)



## WARNING

**KEEP EXPOSED SKIN AWAY FROM ESCAPING GAS WHEN INSTALLING OR REMOVING AIR SUPPLY OR IF THE MARKER OR AIR SUPPLY IS LEAKING. COMPRESSED AIR, CO<sub>2</sub>, AND NITROGEN GASSES ARE VERY COLD AND CAN CAUSE FROSTBITE UNDER CERTAIN CONDITIONS.**

**Step 2:** To remove a charged air supply cylinder:  Eye protection designed for paintball use must be worn by the user and any person within range.  Unload Your Marker (follow the instructions on page 12).

**Step 3:** Watch the marks on the cylinder and cylinder valve as you  Turn the cylinder approximately 3/4 of a turn counterclockwise . This allows the air supply pin valve to close so that no air will enter the marker.  Point the marker in a safe direction and discharge the remaining gas in the marker by pulling the trigger until the marker stops firing (this may take 4-5 shots). If your marker continues to fire, the tank pin valve has not closed yet (the tank pin valve could be too long, because of the variances in tank pin valve parts, each tank varies slightly on exactly how far it should be turned) and  you will have to turn the tank counterclockwise  a little further and repeat this step until the marker does not fire,  then remove the tank. NOTE: If during this step, you turned the tank and it began to leak before you pulled the trigger, the tank o-ring should be checked for damage before reassembly (see Repairing Air Supply Cylinder Leaks on page 15).

**Step 4:** After air cylinder is removed,  point & fire the marker in a safe direction until stored air is completely discharged. NOTE: Before storing or disassembling be sure to follow  Unloading Your Marker and  Air Supply Cylinder Removal instructions (see pages 16-18).  Put the trigger safety in safe mode (see page 4) and Install the barrel blocking device (see page 2).



## Repairing Air Supply Cylinder Leaks:

The most common leak occurs from a bad air supply valve o-ring. To replace a valve o-ring you must first remove the bad o-ring then install a new one and lubricate with a few drops of oil. This o-ring is located on the tip of your air supply valve. The best valve o-rings are made of urethane. Urethane o-rings are not affected by high air supply pressures. These may be purchased from Tippmann® or your local paintball dealer.

NOTE: If new valve o-ring does not resolve air supply leak, do not attempt to repair air supply cylinder. Contact Tippmann Sports, LLC, your local paintball dealer or a "C5" Certified Airmith.

## Cleaning & Maintenance

Eye protection must be worn during disassembly / assembly. To reduce the chance of accidental discharge: First follow  Unloading Your Marker and  Air Supply Cylinder Removal instructions on pages 16-18. Do not disassemble this marker while it is pressurized with air. Do not pressurize a partially assembled marker.

- Follow warnings listed on the air supply cylinder for handling and storage.
- Familiarize yourself with instructions listed on air supply cylinder or adaptor. Contact the air supply cylinder or adaptor manufacturer with any questions.
- Do not use any petroleum based cleaning solvents.
- Do not use any cleaning solvents that come in aerosol cans. NOTE: Petroleum based products and aerosol products can damage your markers' o-rings.
- To clean your paintball marker use a damp towel with water to wipe off paint, oil, and debris. Use Tippmann® marker oil or other premium marker oil to maintain your marker in good working condition.
- To clean inside the barrel. Depress the feed elbow lock  and tip out feed elbow . Insert the cable squeegee into the breech, then pull the squeegee through the barrel to remove debris.
- Inspect and lubricate the internal drive assembly parts:
  - the front bolt o-ring,  the rear bolt o-ring,  the linkage arm and  the drive spring / guide pin (see Marker Disassembly / Assembly, internal parts removal and installation instructions on pages 16-19).
- Inspect and lubricate the barrel o-ring and the air supply valve o-ring with a few drops of oil.

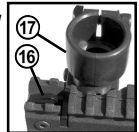

## Storage

Before storage  unload and  remove air supply (follow instructions on pages 12-14).  Put the trigger safety in Safe Mode (see page 4) and

Storage: (continued from page 15)

install the barrel blocking device (see page 2). You should store your marker in a dry area. Before storing your marker make sure that the marker is cleaned and oiled (see cleaning and maintenance on page 19) so that it does not rust. Store your marker with the bolt in the forward position, uncocked (see below).

□ When removing your marker out of storage make sure the trigger safety is in Safe Mode (see page 4) and the barrel blocking device is installed (see page 2). You should re-oil the rear bolt o-ring and the front bolt o-ring before use (see cleaning and maintenance on page 15).

## Marker Disassembly / Assembly

□ Eye protection designed for paintball use must be worn by the user and any person within range during disassembly / assembly.

First follow □ Unloading Your Marker and □ Air Supply Cylinder Removal instructions on pages 12-14. Do not disassemble a pressurized paintball marker. Do not pressurize a partially assembled paintball marker.

□ Put the marker into the uncocked position. To uncock the marker: Pull and hold the bolt cocking handle ① back A↔ - then pull the trigger and release the handle slowly forward ↔ B which will uncock the marker.



**NOTE:** Carefully hand start all threaded parts and do not overtighten and strip threaded parts when assembling.

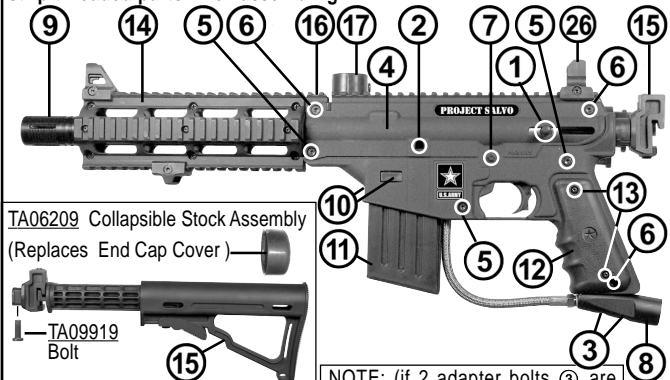

TA06209 Collapsible Stock Assembly  
(Replaces End Cap Cover)



Collapsible Stock Assembly not  
Shown in basic parts pages 10-11).

**NOTE:** (if 2 adapter bolts ③ are removed, the short bolt goes in front when reassembling).

Marker Disassembly (continued from page 16)

□ Remove the barrel ⑨ unscrew ☞ . □ Remove the magazine ⑪ , press the 2 tabs ⑩ in and slide it out. □ Turn the velocity screw ② in until it stops. □ Loosen the 2 adapter bolts ③ . □ Remove the feed elbow ⑪ , press the feed lock ⑩ , tilt the feed elbow out and slide it off the receiver.

□ To remove the left-side receiver ④ : □ Remove the rear sight ⑫ unscrew bolt ☞ and slide off. □ Unscrew ☞ the 6 receiver connection bolts ( 3 long - ⑤ ) + ( 3 short - ⑥ ). Then carefully lift the left-side receiver to access the internal parts.

□ With left half removed, pull the end cap out to remove the guide pin and drive spring (these parts must be removed before the bolt handle can be removed). Disconnect the linkage arm from the rear and front bolts. Slide the front bolt off the power tube and check the o-ring. Clean and oil the o-ring or if damaged, replace with a new one. Do the same with the rear bolt o-ring.

### Power tube and valve removal.

**NOTE:** Do not remove the gas line fitting unless it is leaking or you need to replace the valve. If you should do so you will need some teflon tape or paste to reinstall it. Carefully hand start all threaded parts and do not overtighten and strip threaded parts when assembling.

□ First, complete Marker Disassembly Instructions (see page 20).

□ **Power tube removal:** To remove the power tube and valve, unscrew ☞ the two valve lock bolts ⑬ from the right side receiver.

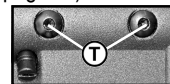

□ **Valve removal from power tube:** If it is necessary to remove the valve, use a wrench (☞☞) to slowly unscrew the gas line fitting. Once the fitting is out, the valve will slide out the back of the power tube.

**NOTE:** □ Check the external valve o-ring and if damaged, replace with a new one. If the o-ring is damaged your marker will not function correctly. □ Clean all parts and oil the o-rings.

□ **Reinstall the valve into the power tube:** Insert cleaned and oiled valve into the power tube and align the holes of the valve and power tube. □ Apply teflon tape or paste on threads of gas line fitting and carefully screw it into the valve and snug with a wrench (☞☞) (do not over tighten and strip threaded parts). □ Wipe off any excess paste.

□ **Reinstall the power tube/valve into receiver:** align the holes of the power tube and the right receiver half, apply red loctite #271 sealant to threads of two valve lock bolts ⑬ and attach ☞ - do not over tighten bolts and strip threads. □ Wipe off any excess paste.

### Reassembling Receiver Halves:

**STEP 1:**  Double check that the Trigger Assembly (  Trigger Spring **A** /  Safety **B** /  Pins (4) **C** /  Trigger **D** /  Sear **E** /  Sear Spring\* **F** /  Sear Pin\* (black) **G** ) ; and other parts:  Front Sight **16** +  Pin\* **H** +  Spring\* **I** ;  Front Bolt\* **J** ;  Ball Latch **K** ;  Linkage Arm\* **L** ;  Link Arm Pins (2) **M** ;  Rear Bolt\* **N** +  Bolt Insert **O** ;  Bolt Handle **1** ;  Drive Spring\* **P** +  Guide Pin\* **Q** ;  Buffer O-ring **R** ;  End Cap **S** +  End Cap Cover **T** ;  2 Tank Adapter Nuts **U** ; are in place and (\*=oiled) (see schematics on pages 10-11 for details as needed).

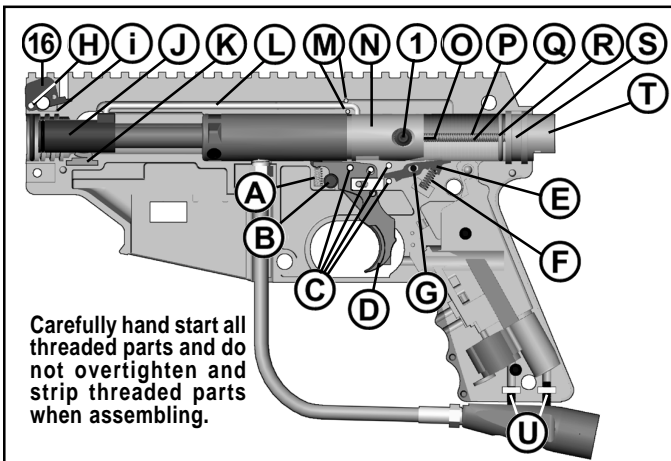

**STEP 2:**  Carefully install the left receiver half (make sure halves fit flush).

- Insert 3 short receiver bolts **6**.
- If marker has a barrel shroud **14** - insert it now.
- Insert 3 long receiver bolts **5** and  tighten **C** the 6 bolts **5**/**6**.
- Attach adapter **8** tighten **C** 2 bolts **3** (NOTE: short adapter bolt goes in front).  Apply marker oil onto the barrel o-ring, insert the barrel **9** and carefully **C** screw it in.
- Slide the feed elbow **17** into the receiver and tilt up until the front sight **16** holds it in place.
- Slide the rear sight **26** on, insert bolt and tighten **C**.

Press in the 2 magazine tabs **10** and slide the magazine **11** up into the marker until the tabs lock it in place. NOTE: The magazine may be used to store tools and lubricating oil for your marker (shown with 2 allen wrenches  and oil).



**WARRANTY AND REPAIR INFORMATION**

TIPPMANN SPORTS, LLC ("Tippmann") is dedicated to quality paintball products and outstanding service. In the unlikely event of a problem with this Tippmann paintball marker ("Marker") and/or Tippmann accessories ("Accessories"), Tippmann's customer service personnel are available to assist you. For customer service and/or other information, please contact:

Tippmann Sports, LLC  
 2955 Adams Center Road  
 Fort Wayne, IN 46803  
[www.tippmann.com](http://www.tippmann.com)  
 1-800-533-4831

**WARRANTY REGISTRATION**

To activate the Marker's Limited Warranty, you must register the Marker within thirty (30) days of the date of original retail sale by:

1. Registering online at [www.tippmann.com](http://www.tippmann.com); or
2. Completing the attached warranty registration card and returning it to Tippmann at the address above.

The Limited Warranty for Tippmann Accessories does not require activation or registration; by registering the Marker, you activate the warranty for the Accessories.

**LIMITED WARRANTY**

Tippmann warrants to the original purchaser that it will make any repairs or replacements necessary to correct defects in material or workmanship, at no charge to you, for the Marker for a period of one (1) year from the date of original retail sale. Further, Tippmann warrants to the original purchaser that it will make any repairs or replacements necessary to correct defects in material or workmanship, at no charge to you, for Tippmann Accessories for a period of ninety (90) days from the date of original retail sale. All Tippmann asks is that you properly maintain and care for the Marker and Accessories (collectively, the "Product") and that you have warranty repairs performed by Tippmann or a Tippmann Certified Tech Center.

This Limited Warranty is non-transferable, and it does not cover damage or defects to the Product caused by (a) improper maintenance; (b) alteration or modification; (c) unauthorized repair; (d) accident; (e) abuse or misuse; (f) neglect or negligence; and/or (g) normal wear and tear.

Tippmann does not authorize any person or representative to assume or grant any other warranty obligation with the sale of this Product.

**THIS IS THE ONLY EXPRESS WARRANTY GIVEN WITH THE PURCHASE OF THIS PRODUCT; ANY AND ALL OTHER EXPRESS WARRANTIES ARE**

WARRANTY AND REPAIR INFORMATION: (continued from page 20)

DISCLAIMED. THE IMPLIED WARRANTIES OF MERCHANTABILITY AND FITNESS FOR A PARTICULAR PURPOSE ARE LIMITED TO THE APPLICABLE LIMITED WARRANTY PERIOD SET FORTH HEREIN, AND NO WARRANTIES, WHETHER EXPRESS OR IMPLIED, SHALL APPLY AFTER EXPIRATION OF SUCH PERIOD.

Some states and nations do not allow limitations on the duration of implied warranties, so the above limitation may not apply to you.

The sole and exclusive liability of Tippmann and/or its authorized dealers under this Limited Warranty shall be for the repair or replacement of any part or assembly determined to be defective in material or workmanship. TIPPMANN SHALL NOT BE LIABLE FOR, AND YOU EXPRESSLY DISCLAIM, ANY DIRECT, INDIRECT, CONSEQUENTIAL OR INCIDENTAL DAMAGES (COLLECTIVELY, "DAMAGES") ARISING OUT OF THE SALE OR USE OF, OR YOUR INABILITY TO USE, THE PRODUCT. NO PAYMENT OR OTHER COMPENSATION WILL BE MADE FOR DAMAGES, INCLUDING INJURY TO PERSON OR PROPERTY OR LOSS OF REVENUE WHICH MIGHT BE PAID, INCURRED OR SUSTAINED BY REASON OF THE FAILURE OF ANY PART OR ASSEMBLY OF THE PRODUCT.

Some states and nations do not allow the exclusion or limitation of incidental or consequential damages, so the above limitation or exclusion may not apply to you. This warranty gives you specific legal rights, and you may also have other rights that may vary from state to state or nation to nation.

**WARRANTY AND NON-WARRANTY REPAIRS**

When shipping the Product to Tippmann for warranty or non-warranty repair:

- (1) If you have aftermarket parts on your Marker, please test the Marker with original stock parts before returning the Marker for service or repair.
- (2) Always unload and remove the air supply from the Marker. Do not ship the air supply tank if it is not completely empty.
- (3) Ship the Product to the Tippmann address identified above.
- (4) You must pre-pay postage and delivery charges.
- (5) Provide the date of purchase for the Product.
- (6) Briefly describe the repair requested.
- (7) Include your name, return address and a telephone number where you can be reached during normal business hours, if possible.

Tippmann makes every effort to complete its repair work within twenty-four (24) hours of receipt. Tippmann will return the Product to you via regular ground UPS. If you wish to have it returned using a faster service, you can request NEXT DAY AIR UPS OR SECOND DAY AIR UPS, but you will be charged for this service and must include your credit card number with the expiration date. Your credit card will be charged the difference in additional cost over regular ground shipping service.

**TIPPMANN**<sup>®</sup>  
2955 ADAMS CENTER ROAD  
FT. WAYNE, IN 46803 USA

Warranty Registration online at [www.tippmann.com](http://www.tippmann.com)  
or complete this warranty card and mail to Tippmann<sup>®</sup>.



Model:  Project Salvo<sup>™</sup>

Serial Number (above left front grip).

#

Purchased from

Date

City

State

Zip

Country

Your Name (print)

Age

Male

Female

Address

City

State

Zip

Country

Phone #

E-mail



INSIDE BACK COVER

# TIPPMANN®

2955 ADAMS CENTER ROAD  
FT. WAYNE, IN 46803 USA

Enregistrement de la garantie en ligne sur [www.tippmann.com](http://www.tippmann.com)  
ou bien remplissez cette carte de garantie et envoyez-la à Tippmann.  
**Registro de Garantía via On line a [www.tippmann.com](http://www.tippmann.com) o complete**  
esta tarjeta de garantía y envíela por correo regular a Tippmann.



**Modèle / Modelo :**  **Project Salvo™**

Numéro de Série (au-dessus du grip avant gauche): \_\_\_\_\_ # \_\_\_\_\_  
Numero de Serie (Número sobre el mango delantero izquierdo).

Acheté chez \_\_\_\_\_ Date \_\_\_\_\_  
Nombre comprador \_\_\_\_\_ Fecha \_\_\_\_\_

Ville \_\_\_\_\_ État \_\_\_\_\_ Code Postal \_\_\_\_\_  
Ciudad \_\_\_\_\_ Estado \_\_\_\_\_ Código Postal \_\_\_\_\_

Pays \_\_\_\_\_

Voire nom \_\_\_\_\_  
Nombre (letra de molde) \_\_\_\_\_

Âge Edad	<input type="checkbox"/> Homme Hombre	<input type="checkbox"/> Femme Mujer
-------------	--	---

Adresse \_\_\_\_\_  
Dirección \_\_\_\_\_

Ville \_\_\_\_\_ État \_\_\_\_\_ Code Postal \_\_\_\_\_  
Ciudad \_\_\_\_\_ Estado \_\_\_\_\_ Código Postal \_\_\_\_\_

Pays \_\_\_\_\_ Téléphone \_\_\_\_\_  
País \_\_\_\_\_ Teléfono \_\_\_\_\_

Courriel \_\_\_\_\_