



PLANET ECLIPSE: CS3

USER MANUAL: ENGLISH



AIR



68 CAL



ECLIPSE® ADVANCED
PAINTBALL TECHNOLOGY

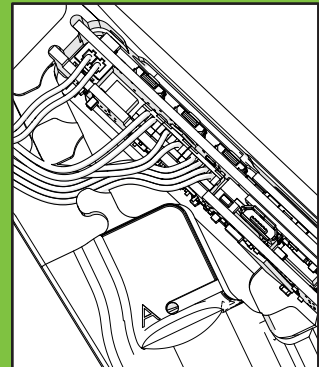
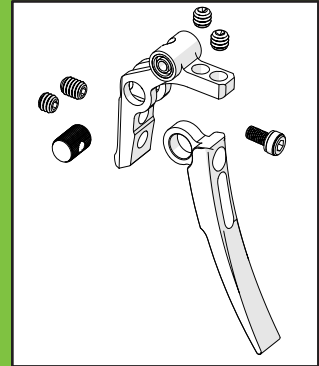
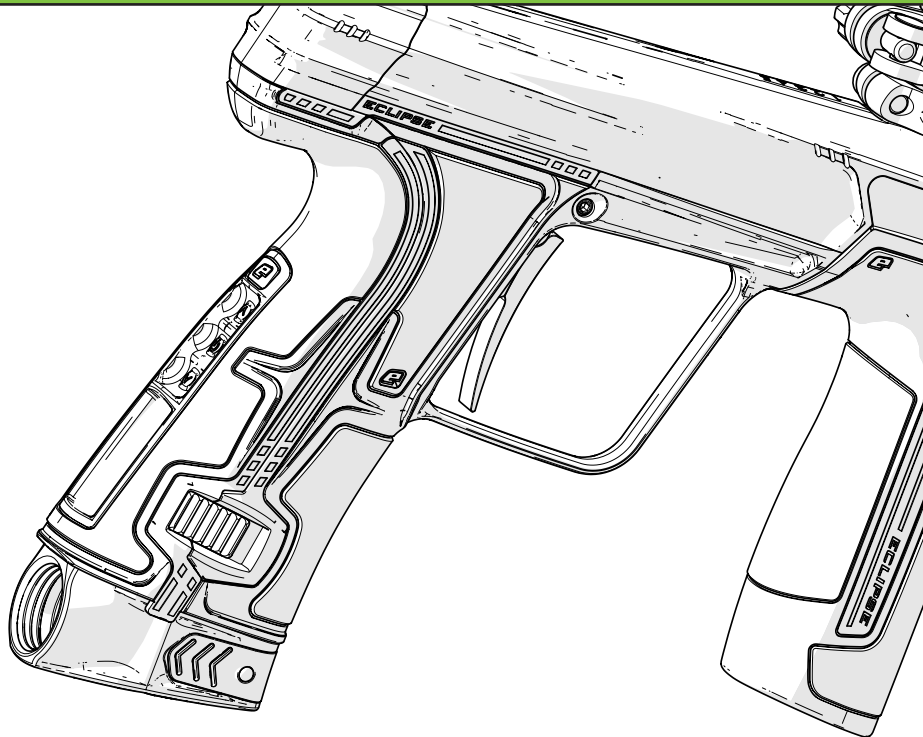



WARNING!

IMPORTANT SAFETY NOTICES

! PLANET ECLIPSE PAINTBALL EQUIPMENT IS NOT A TOY. PAINTBALL SAFETY RULES MUST BE FOLLOWED AT ALL TIMES.

! Careless or improper use of the marker and/or parts, including failure to follow instructions and warnings within this user manual could cause serious injury or even death.

! Do not remove or deface any warnings attached to the marker.

! Paintball industry standard eye/face/ear and head protection designed specifically to stop paintballs and meeting ASTM standard F1776 (USA) or CE standard (Europe) must be worn by the user and any person within range. Proper protection must be worn during assembly, cleaning and maintenance.

! Hearing protection should be worn.

! Never shoot towards a person who is not wearing proper protection.

! Never look directly into the barrel of the marker. Accidental discharge into the eyes may cause permanent injury or even death. Never look into the barrel or breech area of the marker whilst the marker is switched on and able to fire.

! Keep the marker switched off until ready to shoot.

! Treat every marker as if it is loaded and ready to fire.

! The electronic ON/OFF button is the marker's disabling device. Always switch OFF when not in use.

! Always fit a barrel-blocking device when not in use.

! Always remove paintballs from the marker when not in use.

! Do not field strip or remove any parts while the marker is pressurised.

! Do not pressurise the marker without the components of the marker correctly installed; high-pressure gas may be emitted.

! Do not fire the marker without the bolt correctly installed.

! Never put your finger or any foreign objects into the paintball feed tube of the marker.

! Never allow pressurised gas to come into contact with any part of your body.

! Always remove the first stage regulator and relieve all residual gas pressure from the marker before disassembly.

! Always remove the first stage regulator and relieve all residual gas pressure from the marker for transport and storage.

! Always follow guidelines given with your first stage regulator for safe transportation and storage.

! Always store the marker in a secure place.

! Observe all local and national laws, regulations and guidelines.

! Persons under 18 years of age must have adult supervision when using or handling the marker.



WARNING!

IMPORTANT SAFETY NOTICES



- ! Only use professional paintball fields where codes of safety are strictly enforced.
- ! Use compressed air/nitrogen only. Do not use any other compressed gas or pressurised liquid including CO2.
- ! Always follow instructions, warnings and guidelines given with any first stage regulator you use with the marker.
- ! Use 0.68 inch calibre paintballs only.
- ! Always measure your marker's velocity before playing paintball, using a suitable chronograph.
- ! Never shoot at velocities in excess of 300 feet (91.44 metres) per second, or at velocities greater than local or national laws allow.
- ! Any installations, modifications or repairs should be carried out by a qualified individual at a licensed and insured paintball facility.

WARNING !

This user manual must accompany the product in the event of resale or new ownership. Should you be unsure at any stage you must seek expert advice.



THIS USER MANUAL IS IN ENGLISH.

It contains important safety guidelines and instructions. Should you be unsure at any stage, or unable to understand the contents of this manual you must seek expert advice.



LE MODE D'EMPLOI EST EN ANGLAIS.

Il contient des instructions et mesures de sécurité importantes. En cas de doute, ou s'il vous est impossible de comprendre le contenu du mode d'emploi, demandez conseil à un expert.



ESTE MANUAL DE USUARIOS (OPERARIOS)

Usuarios está en Inglés. Contiene importantes normas de seguridad e instrucciones. Si no está seguro de algún punto o no entiende los contenidos de este manual debe consultar con un experto.



DIESE BEDIENUNGS - UND BENUTZERANLEITUNG IST IN ENGLISCH.

Sie enthaelt wichtige Sicherheitsrichtlinien und -bestimmungen. Sollten Sie sich in irgendeiner Weise unsicher sein, oder den Inhalte dies Heftes nicht verstehen, lassen Sie sich bitte von einen Experten beraten.

02	Important Safety Notices	26	Storage and Transportation
04	Let's Go	27	We Got Your Back
05	Welcome to Planet Eclipse	28	Fault Finding Tables
06	Setting up	32	Servicing Intervals
08	Switching the Marker On/Off	33	Tech Resources
09	User Interface	35	Oled Run Screens
10	Oled Indicators	36	User Interface
14	Firmware Version Check	37	Navigating the User Interface
15	BS Status Indicator	38	Presets
16	Removing the Grips	39	Factory Presets
17	Replacing the Grips	40	User Interface Parameters
18	Battery Replacement	54	Settings Menu Summary
19	Tournament Lock Button	59	Regulatory Approval RN4871
20	Breach Sensors and Detents	60	E-Portal (Version 4.5 or Later)
21	Velocity Adjustment	61	E-Portal Lite
22	Trigger Adjustment	62	Bolt Assembly
23	Factory Restore	64	Parts List
24	Unloading the Marker	66	Index

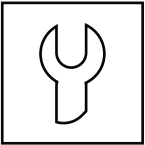

SUPPORT

Eclipse customers have access to our worldwide technical support network that will help you with any technical problems from localised service centres to on-site* tech support.

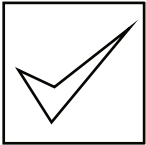

QUALITY

All Eclipse products undergo meticulous checks by experienced specialists who care about the product that arrives at your door. Precision materials + high standards = a quality product.



WARRANTY

Our exceptional 24 months from date of manufacture OR minimum of 12 months with proof of purchase warranty ensures your claim will be repaired or replaced in a snap!

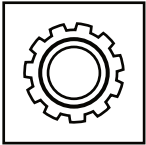

STANDARD

Your Eclipse marker is awesome and requires no after market parts however, for genuine Eclipse accessories and support please consult your local Eclipse Dealer for upgrade options.

* Conditions apply, see online policies for full details at planetecclipse.com

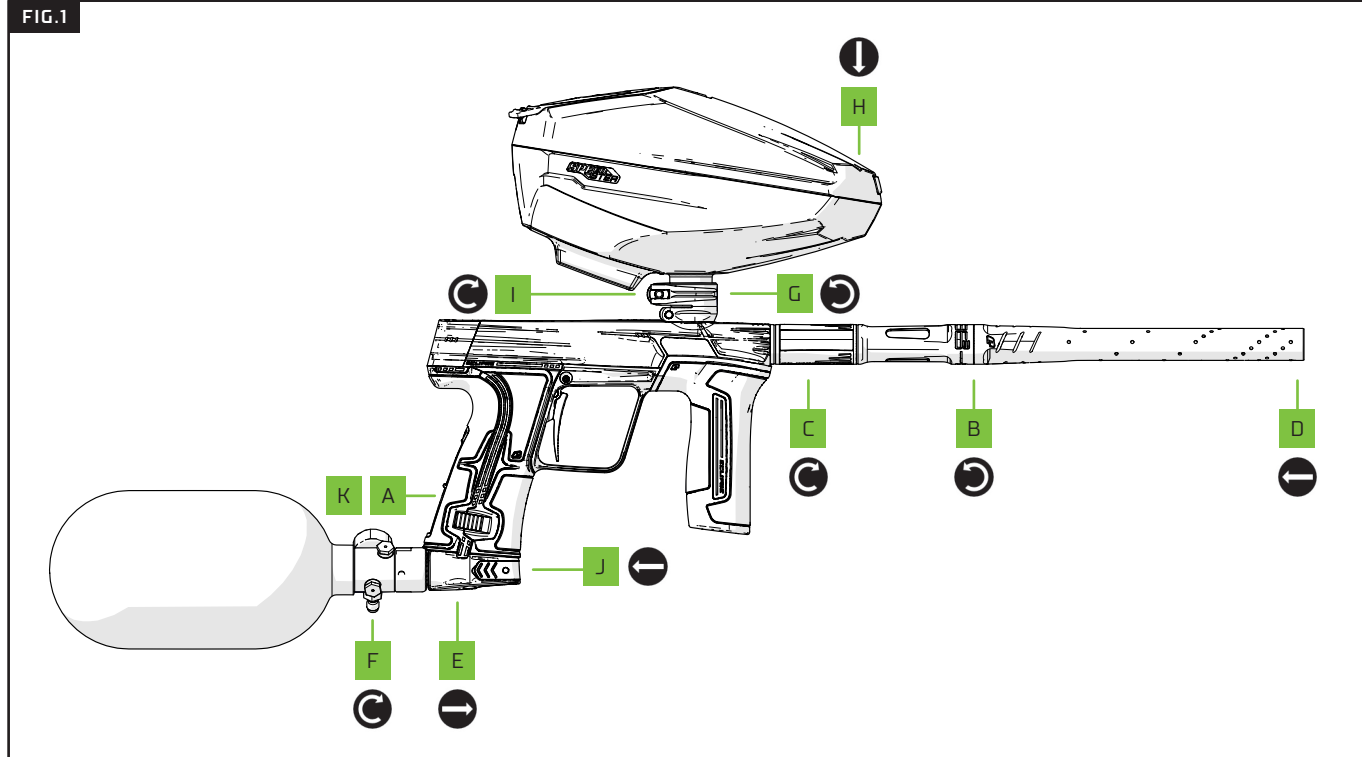

FIG.1

- A SWITCH MARKER OFF BEFORE YOU BEGIN.**
- B BUILD THE 3-PIECE S63 BARREL.**
Slide the insert into the back section.
Rotate the barrel tip counter-clockwise onto the back.
- C ATTACH THE COMPLETE BARREL TO THE MARKER.**
Rotate the barrel clockwise into the marker body.
- D FIT A BARREL BLOCKING DEVICE FOR SAFETY.**
- E ENSURE THE MARKER IS DE-GASSED.**
Push and hold the POPS button then slide the POPS bonnet away from the POPS body.
- F ATTACH A PRE-SET AIR SYSTEM.**
Rotate the air system clockwise into the POPS body.
- G LOOSEN THE CLAMPING FEEDNECK.**
Open the feedneck lever away from the feedneck.
Rotate the feed wheel counter-clockwise.
- H ATTACH A LOADER.**
- I SECURE THE LOADER.**
Rotate the feed wheel clockwise to tighten.
Close the feedneck lever to secure.
- J GAS THE MARKER.**
Push the POPS bonnet into the POPS body until it engages.
- K SWITCH ON THE MARKER.**

- !** **IMPORTANT!** To switch ON/OFF see page 08.
- !** **DO NOT** over-tighten the barrel.
- !** **ALWAYS** ensure marker is de-gassed when setting up.
- !** **NEVER** use CO2. Only use compressed air or Nitrogen.

WARNING !

Always make sure that the marker is OFF with a barrel blocking device installed and that no paintballs are in the marker or loader before attaching an air system.

Compressed air and nitrogen systems can be extremely dangerous if handled or used incorrectly.

Only attach an air system certified for use within the country of use.

Never add lubricants or grease into the fill adaptor of the air system regulator.

Ensure that all screws are tightened and no parts are loose before installing an air system.

Do not pressurise the marker without the bolt system correctly installed, as high pressure gas will be emitted.

Do not install a compressed air system or load paintballs into the marker until you feel confident with your ability to handle the marker safely and responsibly.

FIG.1

The navigation console houses the breach sensor (BS) status indicator **A**; the navigation buttons: **Up** **B** **Select** **C** **Down** **D**; and the OLED screen **E**.

SWITCHING ON

Press and hold **Select** (or double-click it *) until the marker powers up. The LED **A** will flash to indicate the BS status. See page 15 for BS status indicator references.

SWITCHING OFF

Press and hold **Select** until TURN OFF? is displayed. Press **Select** again to switch off.

FIRING THE MARKER

Pull the trigger to fire. The BS status indicator (LED) and the breach sensor indicator (OLED) will indicate if the marker is able to fire.

To toggle the breach sensor on/off push and hold **Up** for 0.5 seconds when the marker is on. See page 10 for BS indicator states.

* Double-click can be disabled in the HARDWARE menu (page 48).

FIG.1

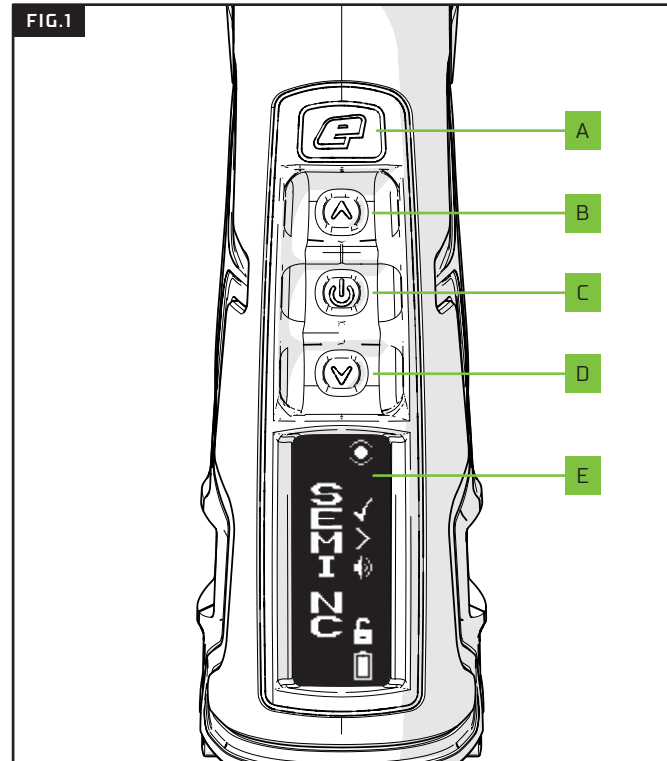

WARNING!

DO NOT dry fire your marker as this may lead to damage over a sustained period.

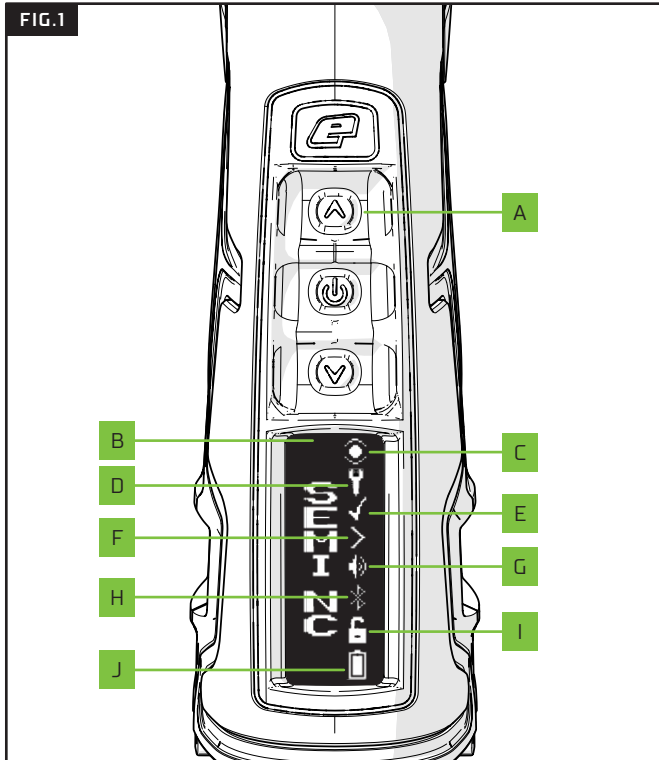

FIG.1

Once powered-up a run screen will be displayed. There are a number of run screens and, with the exception of the Splash screen, they all have the same layout.

- A** Tap **Up** to cycle through the run screens.
- B** Run screen specific information.
- C** The breach sensor (BS) indicator. See page 10 for BS indicator states.
- D** The service indicator.
- E** Factory preset indicator.
- F** The trigger detection indicator.
- G** The sound indicator.
- H** The Bluetooth® indicator.
- I** The tournament lock indicator (to toggle the tournament lock see page 19).
- J** The battery level indicator (see page 13).

FIG.1

The BS indicator **A** displays the various states of the breech sensor.



BS ENABLED AND A BALL IS DETECTED

The marker can be fired up to the selected rate of fire.



BS ENABLED AND NO BALL IS DETECTED

The marker cannot be fired.



BS DISABLED

The marker can be fired up to the rate of fire set by the BS OFF ROF parameter [see page 40].



BS ENABLED IN TRAINING MODE

Training mode is enabled and simulates firing up to the selected rate of fire.



BS DISABLED IN TRAINING MODE

Training mode is enabled and simulates firing up to the rate of fire set by the BS OFF ROF parameter.



BS DISABLED DUE TO DETECTION FAULT

A fault has temporarily disabled the BS and reduced the rate of fire to 2bps below the BS ON ROF parameter.



BS FAULT CLEARED AND A BALL IS DETECTED

A fault has been cleared and the marker can be fired up to the selected rate of fire.



BS FAULT CLEARED AND NO BALL IS DETECTED

A fault has been cleared but the marker cannot be fired.

FIG.1

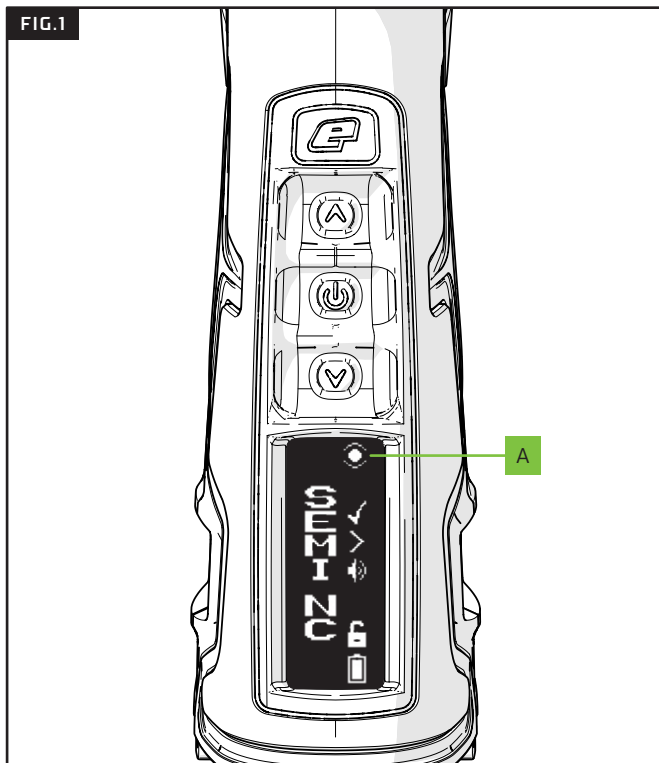

FIG.1

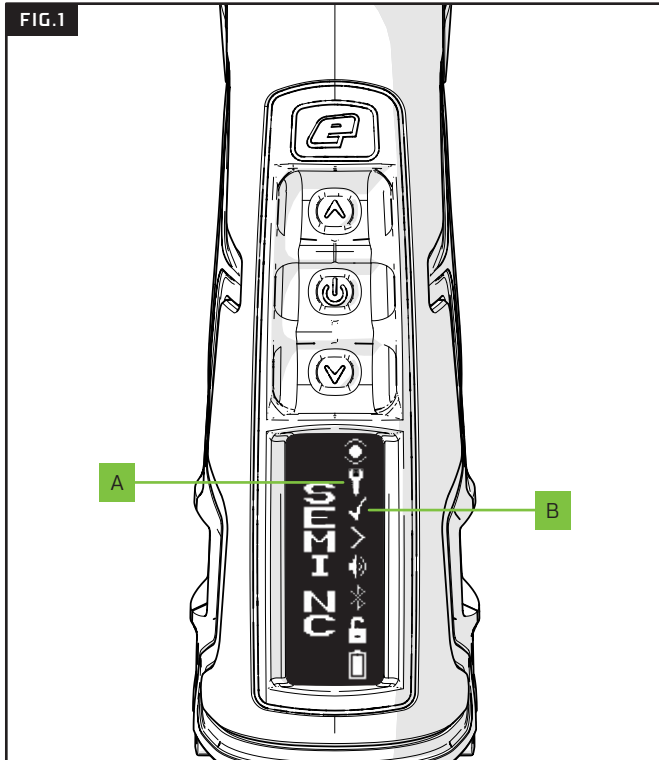

FIG.1

When displayed, the Service Indicator **A** is used to indicate that the marker requires some user maintenance. See page 32 for more.



LUBRICATION REQUIRED

The marker has fired a sufficient number of shots to warrant lubrication.



SERVICE REQUIRED

The marker has fired a sufficient number of shots to warrant a service.

A Preset is a group of parameters designed to control the firing mode of the marker.

A Factory Preset is one that has been built into the marker firmware and is designed to conform with the rules of a particular paintball league or industry recognised standard.

The Factory Preset Indicator **B** is used to indicate whether or not the currently selected preset is one of the Factory Presets.



FACTORY PRESET

The parameters conform to a factory preset.



NOT A FACTORY PRESET

The parameters do not conform to a factory preset.

FIG.1

The Trigger Detection Indicator **A** is used to indicate the state of the trigger.

**MICROSWITCH NOT ACTUATED**

The trigger is in a released or forward state.

**MICROSWITCH ACTUATED**

The trigger is in a pulled or rearward state.

The sound indicator **B** is used to indicate whether the speaker is on or off.

**SOUND ENABLED**

Sound is used to indicate certain events.

**SOUND DISABLED**

Sound has been muted.

When displayed, the Bluetooth® indicator **C** is used to indicate that Bluetooth® is enabled. Only applicable if the Bluetooth® module has been installed.

**BLUETOOTH® ENABLED**

Bluetooth® is On.

IMPORTANT: If the Bluetooth® module is NOT installed then all relevant Bluetooth® parameters will be automatically excluded from the menus.

FIG.1

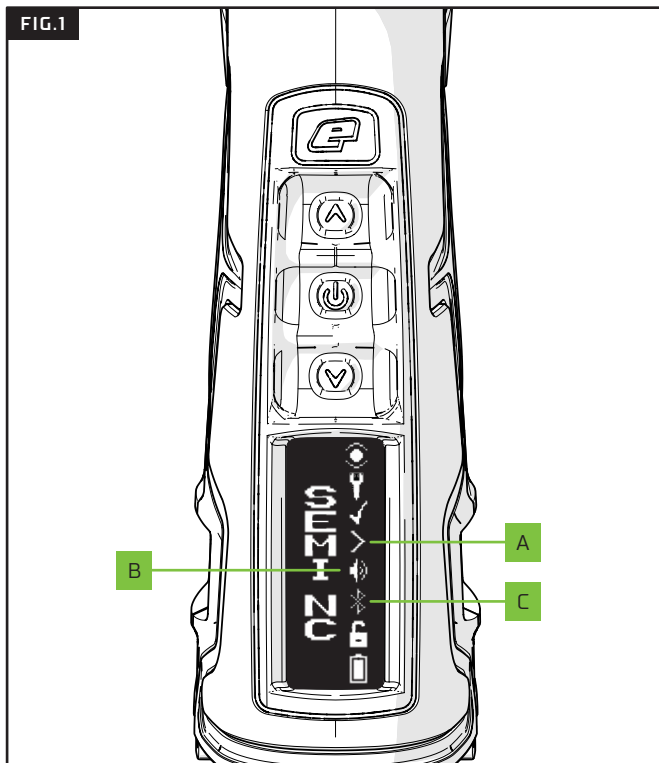

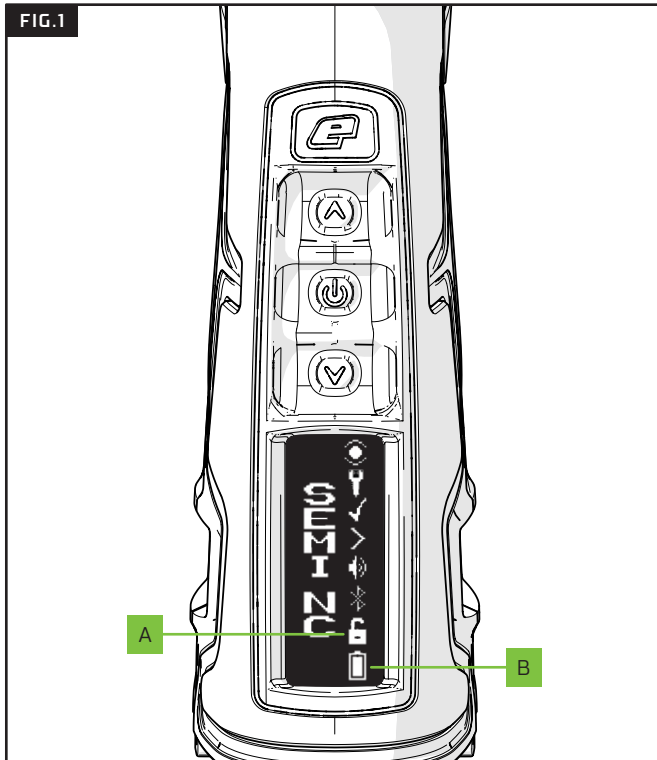

FIG.1

The Lock Indicator **A** shows the status of the Tournament Lock (see page 19 to change the lock state).



LOCKED

Firing mode parameters cannot be changed. This is a tournament legal mode of operation.



UNLOCKED

Firing mode parameters can be changed.

The Battery Indicator **B** shows the level of charge the battery has.



FULL BATTERY

The battery is fully charged.



50% DRAINED BATTERY

The battery level is 50% drained and should be monitored.



DRAINED BATTERY

The battery should be changed.



BATTERY CIRCUIT FAULT

The battery level cannot be determined.



ESTIMATED BATTERY

The battery level is estimated and not accurate until the marker is fired.

FIG.1

To check which version of firmware is currently installed in the marker, do the following -

- 1 Push and hold **Select** **A** to switch the marker on.
- 2 When the marker logo appears, let go of **Select**.
- 3 The version screen will now be displayed. *

The firmware number **B** indicates the version of the control program and the bootloader number **C** indicates the version of the bootloader, a separate program used to connect to a PC for the purpose of performing firmware updates.

* If you push and hold Select when the version screen appears, the screen will remain until Select is released.

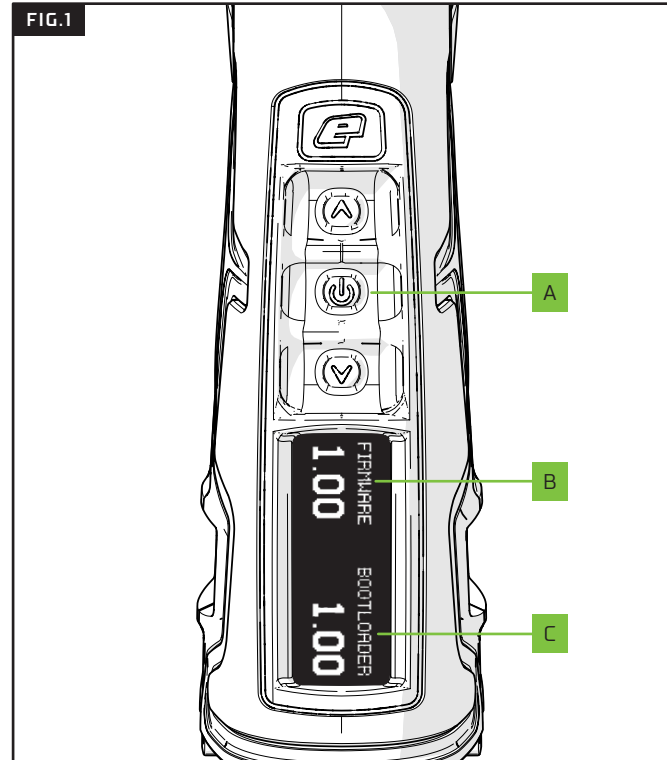

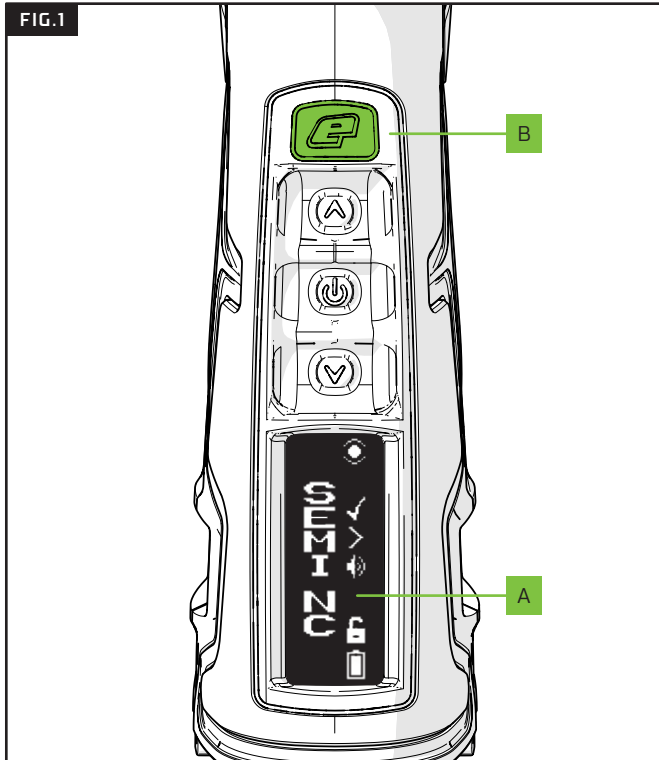

FIG.1

In addition to the OLED user interface **A** the navigation console also houses the flashing BS status indicator **B**.

The BS status indicator will flash and change colour depending on the breach sensor's operational status.

See table below.

LED INDICATION	BS STATUS
Flashing Yellow	BS enabled. No paintball detected. Marker will NOT fire.
Flashing Light Blue	BS enabled. Paintball detected. Marker WILL fire.
Flashing Purple (Slow)	BS disabled. Marker WILL fire.
Flashing Purple (Fast)	Blockage detected. BS disabled. Marker WILL fire.
Flashing Red	Training mode enabled. Marker will NOT fire but will make a sound instead.

FIG.1

The marker MUST be degassed and the bolt bonnet pulled up before the grips can be removed. Then, slide the grip retainer tabs forwards **A** which will unlock the grip halves. This needs to be done on both sides of the grips.

FIG.2

Use the plastic section of the rear grip **B** to leverage the rear grip away from the frame.

FIG.3

Lift and pull the rear grip section **C** away from the frame.

FIG.4

Lift and pull the front grip section **D** away from the frame.

Removing the grips will allow access to the tournament lock, wiring, circuit board and its connections.

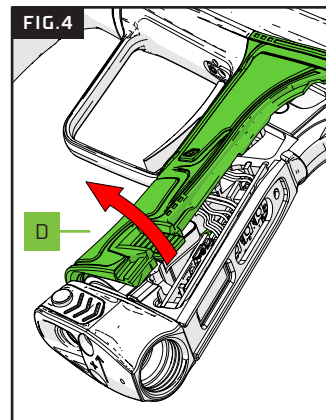
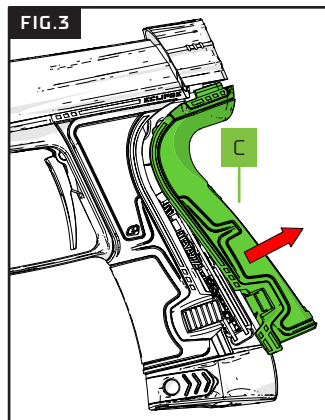
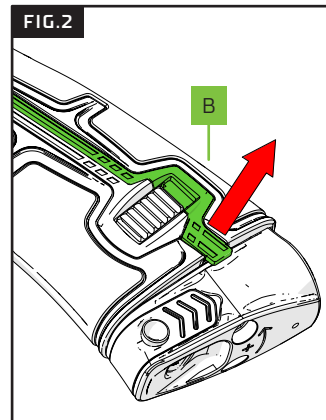
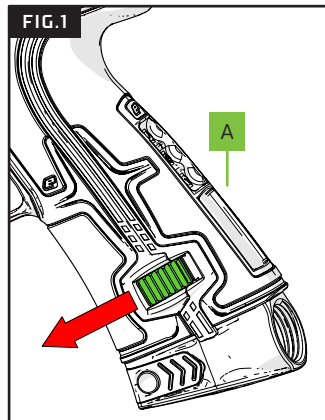
**WARNING!**

Always make sure that the marker is OFF with a barrel blocking device installed and that no paintballs are in the marker or loader before removing/replacing the grips.

INTRODUCTION

REPLACING THE GRIPS

17

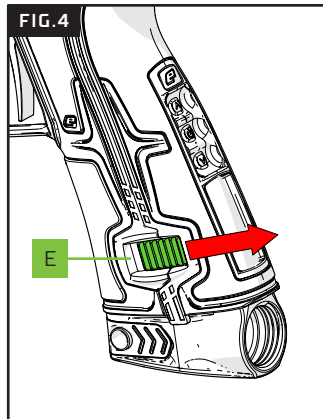
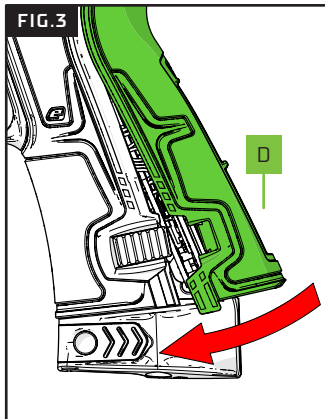
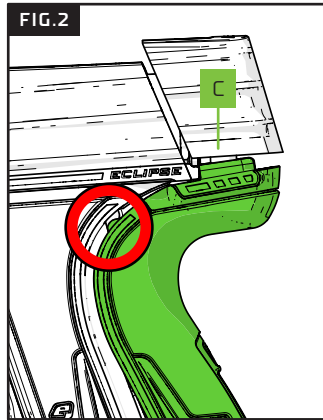
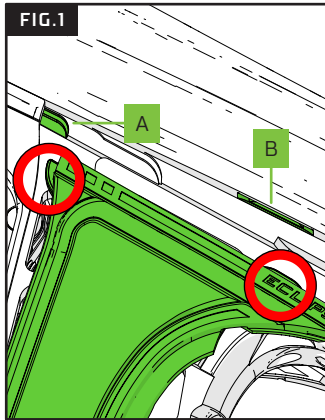

FIG.1

Replace the grips in the reverse order of how you removed them. You **MUST** check that the location tabs in the front grip section (circled) clip beneath the body **A B** before fitting the front grip section.

FIG.2

This also applies to the rear grip section. Make sure the location tab (circled) clips into place and the rear tabs **C** sit beneath the bolt bonnet. Note, the bolt bonnet must be in the UP position when fitting, then DOWN to secure the rear grips.

FIG.3

Once the location tabs are in place simply swing the rear grip section into place **D**.

FIG.4

Finally, push the grip retainer tabs towards the back of the grip to secure the complete grip **E**.

WARNING!

Always make sure that the marker is OFF with a barrel blocking device installed and that no paintballs are in the marker or loader before removing/replacing the grips.

This marker uses 2 x AA Alkaline batteries for power. Accessing and replacing them is a breeze.

FIG.1

Access the battery holder by firmly pulling the rubber foregrip sleeve downwards **A**.

FIG.2

To access the batteries you must push in (or squeeze) the locking tabs **B** from both sides then the battery retainer will easily slide out.

FIG.3

Being careful not to let the contents fall out, the battery retainer **C** and batteries (if present) **E** will be easily removed.

Always follow the battery orientation guide **D** when installing 2 x AA batteries **E**. Incorrect installation means the marker will not power up or function.

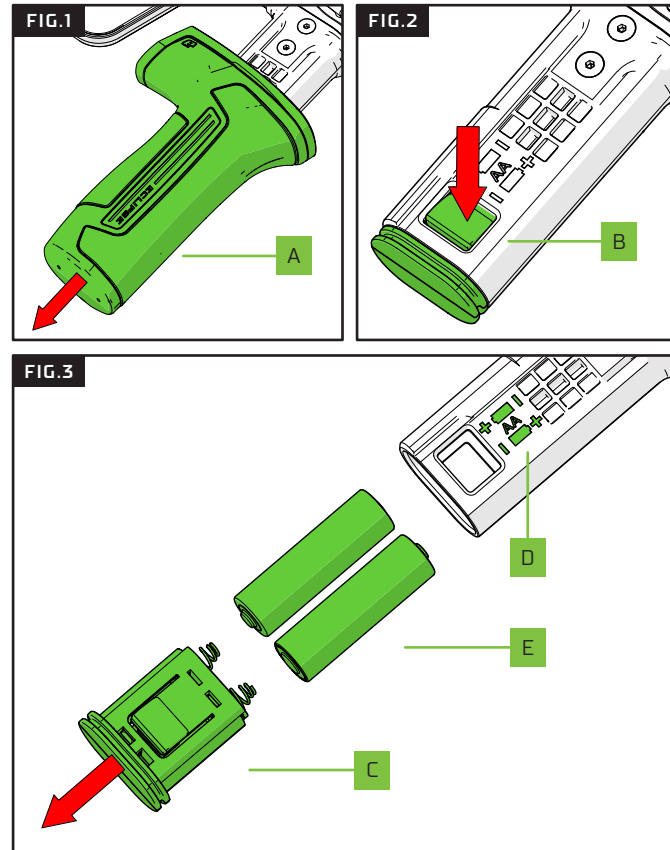
**IMPORTANT!**

ALWAYS use good quality AA batteries. DO NOT use rechargeable batteries.

Follow battery orientation guide on the battery housing.

INTRODUCTION

TOURNAMENT LOCK BUTTON

19

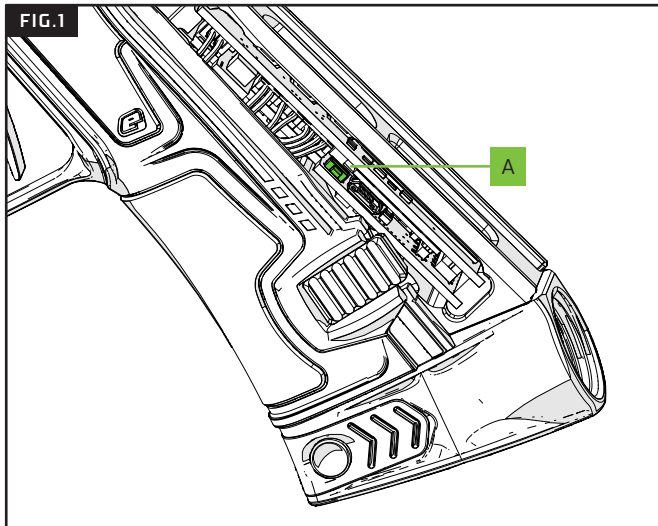

FIG.1

Remove the rear grip as shown on page 16 to access the tournament lock button **A** on the left side of the frame.

FIG.2

Push the tournament lock button **A** to toggle the tournament lock state – which will be displayed on the OLED screen. See page 13 for lock state information.

Many of the marker features and settings require the tournament lock state to be set to UNLOCK.

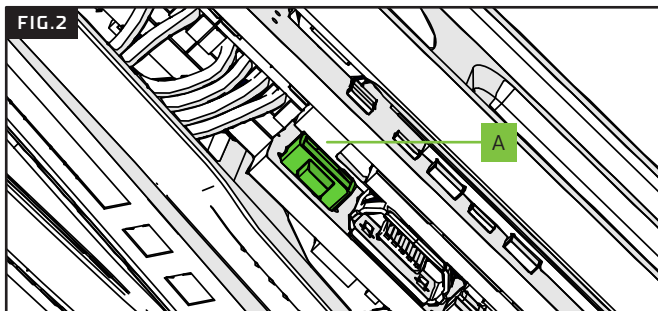

WARNING!

Always make sure that the marker is OFF with a barrel blocking device installed and that no paintballs are in the marker or loader before changing the tournament lock state to avoid accidentally firing the marker.

FIG.1

Once the foregrip sleeve has been removed (see page 18) you can access the breach sensor (BS) cover release clips **A** which are on both sides of the marker. Slide the clips forwards (towards the barrel) to release the breach sensor (BS) covers.

FIG.2

The BS covers **B** will now be free to remove.

FIG.3

Simply lift the BS covers **B** away from the body to expose the BS sensors **C** rubber detents **D** and spare detent **E**.

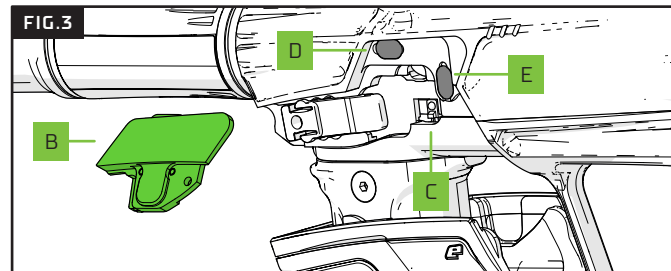
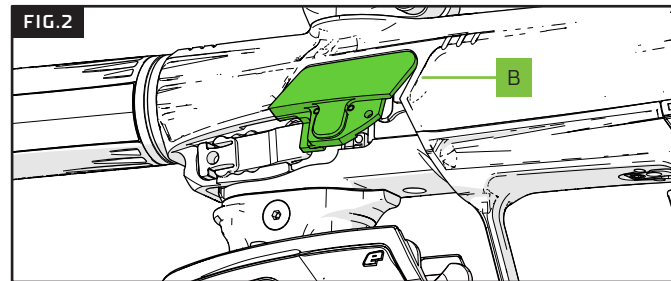
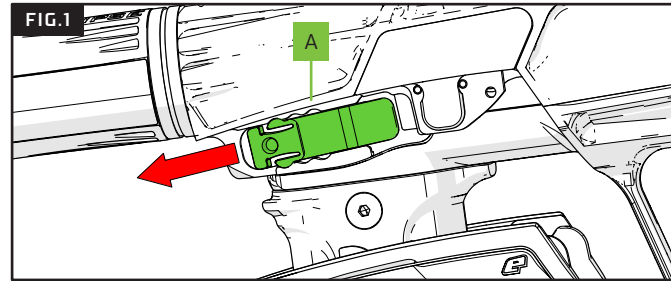

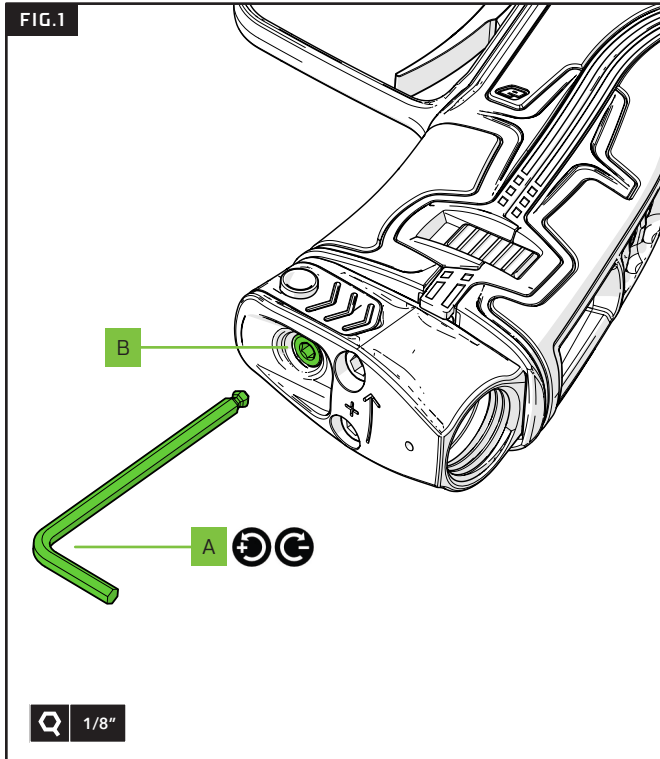

FIG.1

The velocity adjustment screw is accessed from the bottom of the grip/POPS. Insert a 1/8 hex key **A** into the adjuster screw **B** to increase/decrease the velocity.

Turn the hex key clockwise to reduce velocity.

Turn the hex key counter-clockwise to increase velocity.

- ! Fire two clearing shots after each velocity adjustment for an accurate velocity reading.
- ! **DO NOT** turn the adjustment screw in too far as this will prevent the marker from firing.

WARNING!

DO NOT exceed 300FPS

ALWAYS wear correct protective equipment when firing your marker.

NEVER point your marker in the direction of other people when not on the field.

ALWAYS be aware of where the barrel is facing when adjusting the velocity.

FIG.1

The rake adjustment screw (5/64) **A** controls the angle of the trigger shoe. Rotate the screw counter-clockwise to loosen the shoe for manual adjustment. Clockwise to secure the shoe in place.

Spring return screw (1/16) **B** adjusts the spring strength of the trigger return. Clockwise increases the strength, counter-clockwise decreases it.

The (1/16) post-travel screw **C** adjusts the distance the trigger travels once pulled. Clockwise reduces the amount of travel (shortening the trigger) counter-clockwise increases the trigger pull distance.

The (1/16) pre-travel screw **D** adjusts the distance the trigger travels before being pulled. Clockwise reduces the amount of travel (shortening the trigger), counter-clockwise increases the distance.

The (1/16) magnet adjuster screw **E** adjusts the strength of the trigger return. Clockwise increases the strength, counter-clockwise reduces it.

Trigger retaining screw (5/64) **F** holds the trigger assembly in place. Removing this allows the assembly to be removed via trigger guard. Counter-clockwise to remove the screw, clockwise to secure.

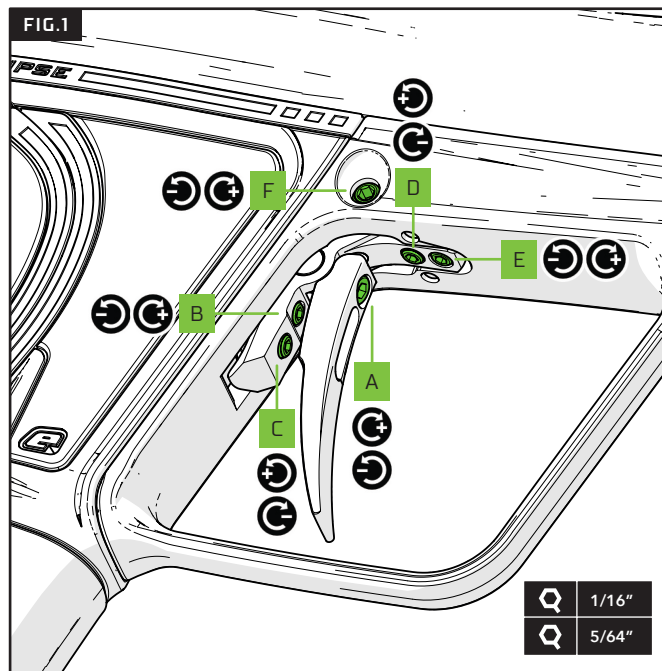

WARNING!

DO NOT wind the screws in too far as this may prevent the marker from firing, or even damage it. If pre-travel screw is wound in too far the marker may fire unintentionally.

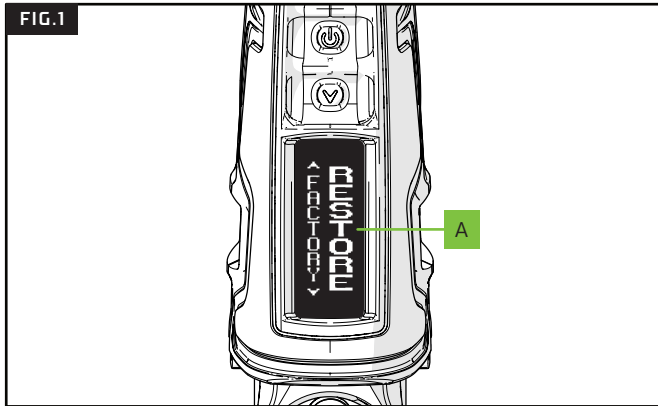

FIG.1 - FACTORY RESTORE

Navigate to the **HARDWARE > FACTORY** menu item and select the **RESTORE** option **A**. This will cause the marker to reconfigure any new hardware (such as a Comms Board) and restore the electronics and firmware to their default state. Any user modifications will be lost, however the E-Portal PC application can be used to save them prior to performing a RESTORE.

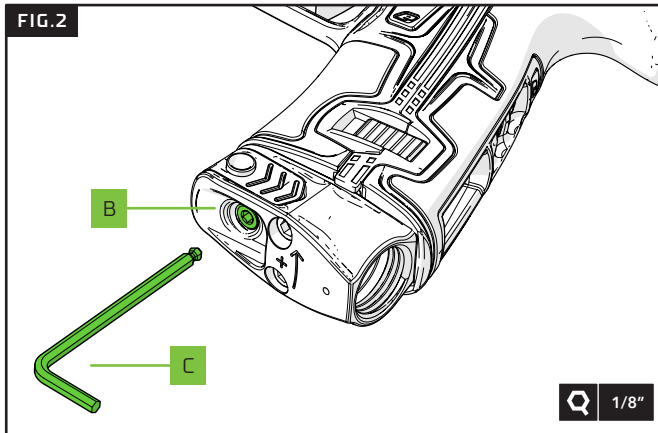

FIG.2 - VELOCITY

Using the 1/8 hex key **B** turn the velocity adjuster screw **C** counter-clockwise until it is in the full screwed-out position. Then wind it in 3.5 turns clockwise.

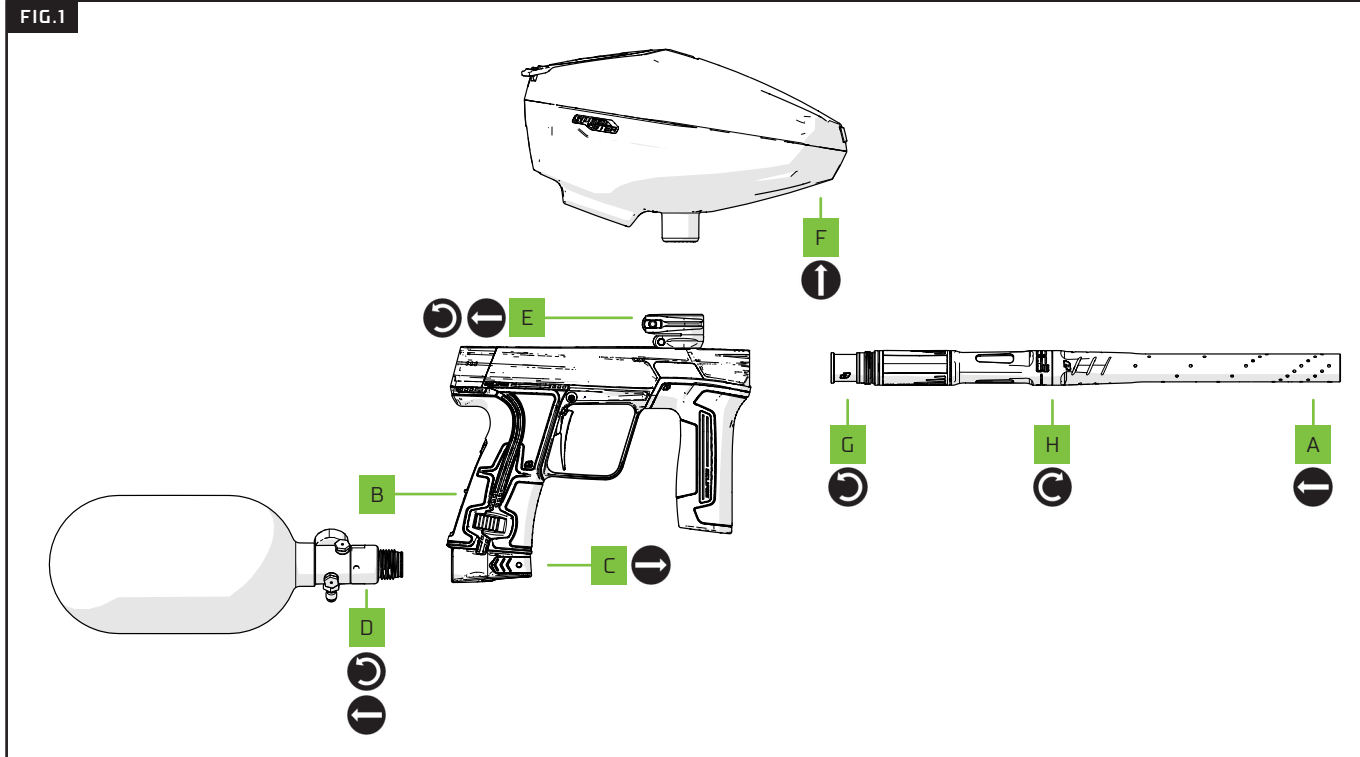

FIG.1

- A ENSURE THAT A BARREL BLOCKING DEVICE IS FITTED.**
To prevent accidentally firing a paintball when unloading. Remove barrel blocking device after step **F**.
- B SWITCH THE MARKER OFF.**
- C DE-GAS THE MARKER.**
Push in and hold the POPS button and slide the POPS bonnet away from the POPS body.
- D REMOVE THE PRE-SET AIR SYSTEM.**
Rotate air system counter-clockwise from the POPS body.
- E LOOSEN THE CLAMPING FEEDNECK.**
Open the feedneck lever away from the feedneck. Rotate the feed wheel counter-clockwise.
- F REMOVE THE LOADER.**
If the feedneck is too tight, loosen the feed wheel.
- G REMOVE THE S63 BARREL FROM THE MARKER BODY.**
Rotate the barrel counter-clockwise to remove.
- H DISASSEMBLE THE S63 BARREL.**
Rotate the barrel tip clockwise to remove. Slide the PWR Insert out from the back section.

- !** **IMPORTANT!** To switch OFF/ON, see page 08.
- !** **IMPORTANT!** Always de-gas before unloading.
- !** **IMPORTANT!** Always remove air system before unloading.
- !** **IMPORTANT!** Always remove any paintballs from the breech of the marker once the loader has been removed.
- !** **IMPORTANT!** The barrel tip is reverse threaded so unscrew it **CLOCKWISE**.

WARNING!

Always make sure that the marker is OFF with a barrel blocking device installed and that no paintballs are in the marker or loader before attaching an air system.

Compressed air and nitrogen systems can be extremely dangerous if handled or used incorrectly.

Only attach an air system certified for use within the country of use.

Never add lubricants or grease into the fill adaptor of the air system regulator.

Ensure that all screws are tightened and no parts are loose before installing an air system.



Do not pressurise the marker without the bolt system correctly installed, as high pressure gas will be emitted.

Do not install a compressed air system or load paintballs into the marker until you feel confident with your ability to handle the marker safely and responsibly.

- ! Your marker must be clear of all paint and propellant during transportation or storage.
 - ! Make sure the marker is switched OFF.
 - ! Remove the barrel from the marker.
 - ! Make sure the marker is clean of any paint residue, dirt and moisture.
 - ! Store your marker in a clean, cool, dry place.
 - ! Keep your marker away from any unauthorised, unprotected or unsafe users.
- ! Protect your marker from excessive heat during transportation.
 - ! When transporting a paintball marker by air, check with the airline regarding their policies on transporting paintball equipment as hold luggage before arriving at the airport.
 - ! Observe and obey all local and national laws concerning the transportation of paintball markers.
 - ! Use the box in which the marker was originally supplied to protect the marker against rough handling during transport.

WARNING!

Never carry your marker un-cased when not on a playing field. The non-playing public and law enforcement personnel may not be able to distinguish between a paintball marker and a real firearm. For your own safety and to protect the image of paintball, always carry the paintball marker in a suitable marker case, such as the one in which it was supplied.

	<h2>TECH SUPPORT</h2> <p>Scan to access our live tech support hub. Facebook.com/groups/petechhub</p>
	<h2>TECH ROOM</h2> <p>Scan to watch in-depth tech guidance videos. Youtube.com/planeteclipseTV</p>
	<h2>MANUALS</h2> <p>Scan to access our archive of product manuals. Planeteclipse.com/manuals</p>
	<h2>WARRANTY</h2> <p>Scan to check warranty support eligibility. Planeteclipse.com/warranty</p>

From our live tech services, instructional video guidance and ongoing warranty support you'll quickly discover that our reputation for industry-leading after-sales care goes way beyond anything you've experienced before.

So pat yourself on the back for making the right choice and welcome to the family.

#WEGOTYOURBACK

SYMPTOM	POSSIBLE CAUSE	SOLUTION
The CS3 does not cycle fully.	The bolt assembly is dirty or incorrectly lubricated.	Clean, re-lubricate and replace the o-rings on the bolt as necessary.
	The DWELL parameter is set too low.	Increase the DWELL parameter.
	A sticky or faulty solenoid spool in the solenoid body.	Check the spool, clean and replace seals as necessary.
	There is a fault with the solenoid pilot.	Replace the solenoid pilot.
	The battery power is low or the batteries are of a poor quality.	Replace the batteries. Use alkaline or lithium batteries. Always use high quality batteries.
The CS3 is inconsistent.	The paintballs are too tight in the barrel.	Use a better paintball to barrel bore size match.
	The DWELL parameter is set too low.	Increase the DWELL parameter.
	Using poor quality paintballs.	Use better quality paintballs.
	A poor paintball to barrel bore match.	Use a better paintball to barrel bore size match.
	The inline regulator requires servicing.	Strip and clean inline regulator. Replace o-rings and regulator seal.
The CS3 is inefficient.	Poor / inconsistent air supply to the POPS.	Use a good quality preset air system.
	Poor main spool performance.	Clean and grease rear main spool seals. Check condition of spool spring.
Rate of fire is low and can't be altered.	A poor paintball to barrel bore match.	Use a better paintball to barrel bore size match.
The CS3 has low velocity on the first shot.	Issues with the loader.	Try a different loader. Replace loader batteries. Check force and sensitivity settings.
	The FSDO parameters are set too low to overcome o-ring stiction.	Adjust FSD COMP and FSD DLY parameters.
CS3 has velocity drop-off during rapid fire.	The bolt assembly is dirty or incorrectly lubricated.	Clean, re-lubricate and replace the o-rings on the bolt as necessary.
	The batteries are poor quality or have insufficient charge.	Replace the batteries. Use alkaline or lithium batteries. Always use high quality batteries.
	Air system/regulator doesn't flow fast enough to keep up.	Use a good quality preset air system.
	The bolt assembly is dirty or incorrectly lubricated.	Clean, re-lubricate and replace the o-rings on the bolt as necessary.
	Poorly maintained inline regulator.	Strip, lubricate and rebuild the inline regulator. Replace Regulator Seal.

SYMPTOM	POSSIBLE CAUSE	SOLUTION
The CS3 is breaking paintballs in the barrel or the breech.	The loader force feed setting is too high.	Adjust the loader to a lower force feed setting.
	The ball detents are damaged or missing.	Replace the ball detents.
	Poor quality paintballs.	Use better quality paintballs.
	The breech sensor is switched off.	Switch on the breech sensor.
	A poor paintball to barrel bore match.	Use a better paintball to barrel bore size match.
	Unseated rubber bolt tip.	Reseat the rubber bolt tip.
	Missing or damaged rubber bolt tip.	Replace the rubber bolt tip.
On power up the marker will not fire.	The trigger is permanently depressed.	Adjust the trigger until the trigger microswitch is de-activated when the trigger is released.
Constant high velocity / Unable to lower velocity to desired fps.	Output pressure of the preset regulator is too high.	Use a preset regulator with an output pressure below 650 psi. Consult the preset regulator manufacturer for possible faults / maintenance requirements.
Although a fresh battery has been fitted, the CS3 will not switch on.	The batteries have drained on the shelf.	Replace with new batteries.
	The batteries are fitted incorrectly.	Remove the batteries and replace correctly.
The batteries do not seem to last very long.	The batteries are of a low quality.	Use alkaline or lithium batteries. Do not use low quality or rechargeable batteries.
The CS3 leaks from the solenoid and/or manifold.	The gaskets between the body and the solenoid or the solenoid and the frame are damaged, dirty or missing.	Ensure the gaskets are clean and seated correctly.
		Replace the gaskets if damaged or missing using CS3 parts kit.
	Pilot valve and/or manifold are over-pressurised.	Check the output pressure of the inline regulator, adjust accordingly.
		Clean and inspect the inline regulator assembly paying particular attention to the piston o-ring, piston tip and regulator seal.
		Replace damaged components as necessary.
	Damaged or incorrect seals on the solenoid spool.	Replace and/or lubricate solenoid spool seals.
Damaged solenoid pilot valve.	Replace solenoid pilot valve.	

SYMPTOM	POSSIBLE CAUSE	SOLUTION
The CS3 leaks down the barrel.	Dirty or damaged can o-rings.	Clean and lubricate or replace 020 NBR70 and 017 NBR70 o-rings on the front of the can.
	Dirty or damaged o-rings on the spool.	Clean and lubricate or replace the 011 NBR70 and 012 NBR70 o-rings on the main spool.
	Dirty or damaged bolt o-rings.	Clean and lubricate or replace 14x2 NBR70 o-ring on the back of the bolt.
	Dirty or damaged rear bolt guide o-ring.	Clean and lubricate or replace 017 NBR70 o-ring on the back of the bolt guide.
Low rate of fire / rate of fire not reaching the ROF cap.	The force setting of the loader is too low.	Adjust the loader force feed setting.
	The breech sensor has detected a fault and has reduced the ROF.	Check the position and condition of the breech sensors.
		Clean the breech sensors as required.
Low constant velocity.	The inline regulator output pressure set too low.	Increase the output pressure of the inline regulator.
High velocity first shot.	The inline regulator pressure is creeping.	Strip and clean the inline regulator replacing the piston seal.
The trigger is very "bouncy".	Incorrect filter settings.	Check that your DEBOUNCE settings suit your trigger set-up.
	Trigger pull is too short and the return strength is too low.	See page 22 for trigger adjustment guidelines.
The CS3 does not fire.	The CS3 is not powered up.	Power up the CS3 using the Select button on the navigation console.
	The POPS is not fully engaged.	Pull the POPS bonnet back until it engages..
	The battery quality or charge level is very low.	Install new high quality alkaline or lithium batteries.
	The batteries are flat.	Replace the batteries.
	The DWELL parameter is set too low.	Increase the DWELL parameter.
	The trigger is set-up incorrectly.	Adjust trigger correctly to fully open and close the microswitch.
	The solenoid is not plugged into the CS3 PCB.	Plug solenoid wire into its port on the CS3 PCB.
	Breech sensor is enabled but no paint is in the breech.	Fill the loader with paint. Check for blockages in loader or feedtube.
	The main PCB is damaged.	Replace the main PCB.
The pilot valve is damaged.	Replace the pilot valve.	

SYMPTOM	POSSIBLE CAUSE	SOLUTION
The breech sensor is not reading correctly.	The light pipes are dirty.	Keep the breech sensor light pipes clean to ensure correct readings.
	The breech sensor is fitted incorrectly.	Check that the light pipes are correctly fitted in the eye cover and the eye covers are correctly fitted and secured to the body.
	The sensors on the main board are bent or dirty.	Ensure the sensors on the breech sensor board are pointing outwards perpendicular to the board and that the lenses are clean.
	The breech sensor cable is not plugged into the main board.	Connect the breech sensor cable.
The breech sensor goes into default mode after firing and the display shows that there is a fault with the breech sensor.	The light pipes are dirty.	Clean the light pipes.
	The pockets in the breech are blocked.	Remove eye covers and clean the pockets in the breech.
	The sensors are out of place.	Check alignment of sensors on the breech sensor board.
Two or more balls are being fed into the breech.	Worn, damaged or missing ball detents.	Change the rubber ball detents.
	The feed force is too high from the loader.	Adjust loader settings/use a lower force loader.
The CS3 emits 2 audible beeps when switched on.	The comms board is not fitted or fitted incorrectly.	Check that no pins are bent and that they are correctly aligned with the sockets. Select RESTORE>FACTORY
	The comms board does not have a BLE module.	Replace with the correct comms board. Select RESTORE>FACTORY.
	The comms board is damaged.	Replace the comms board.

FIG.1

When the Lubrication Required indicator **A** is displayed, the user needs to perform a simple lubrication procedure to maintain the marker's peak levels of performance and reliability. We have a maintenance video outlining this procedure, see page 33.

**LUBRICATION REQUIRED**

The marker has fired a sufficient number of shots to warrant lubrication.

After lubrication the lubrication counter can be reset with **SERVICING > RESET > LUBE**.

FIG.2

When the Service Required indicator **B** is displayed, the user needs to perform a more involved set of procedures to maintain the marker's peak levels of performance and reliability. See page 33.

**SERVICE REQUIRED**

The marker has fired a sufficient number of shots to warrant a service.

After a service the service counter can be reset with **SERVICE > RESET > SERVICE**. Resetting the service counter also resets the lubrication counter.

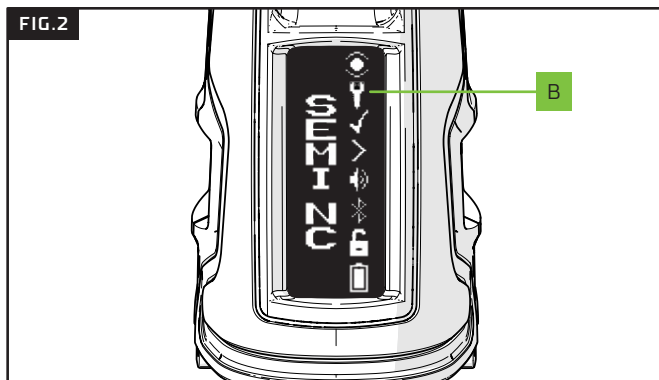
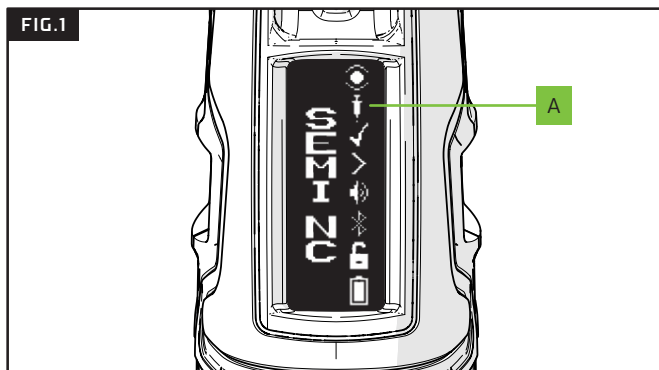

TECH ROOM



WORKSHOP MANUALS

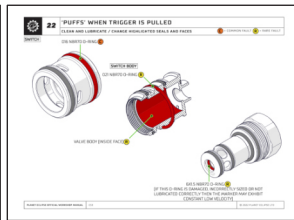
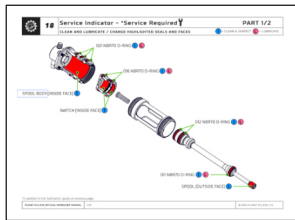
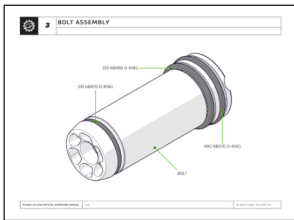

PARTS FINDER

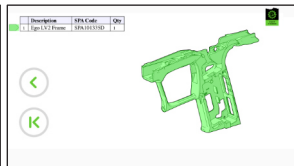

Our frequently updated online Tech assets have been designed to educate and inspire owners to maintain their gear with ease.

Tech Room hosts many platform-specific maintenance videos.

Workshop Manuals give owners an in-depth, technical guide for all aspects of maintenance requirements.

Parts Finder helps owners to locate and identify specific spare part numbers.



TECH ROOM

Scan QR code or head over to:
youtube.com/planetecclipsetv



WORKSHOP MANUALS

Scan QR code or head over to:
planetecclipse.com/manuals



PARTS FINDER

Scan QR code or head over to:
planetecclipse.com/kb/part-finder

MODE SCREEN

This screen allows the firing parameters to be examined quickly without having to enter the setup menu. Tap the bottom pushbutton to cycle through the relevant parameters,

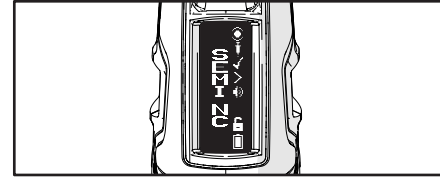

GAME TIMER SCREEN

This screen provides a countdown game timer. Tap the bottom pushbutton to start the game timer countdown. Hold the bottom pushbutton for 0.5 seconds to stop the timer. Push and hold the bottom pushbutton again to reset the game timer. When counting down the marker will sound an audible alarm when it reaches the ALARM 1 time, the ALARM 2 time and 00:00.

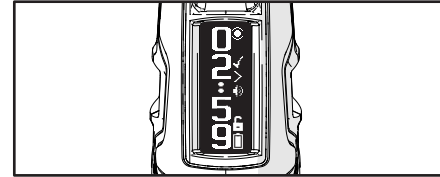

SHOT COUNTER SCREEN

This screen provides a resettable shot counter. Hold the bottom pushbutton to reset the counter.

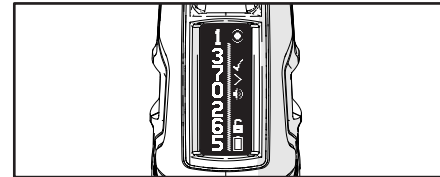

ACTUAL ROF SCREEN

This screen displays the actual ROF recorded over time, along with the latest recorded reading and the maximum recorded reading. The actual rate of fire is the number of shots fired in each second of time. Hold the bottom pushbutton to zero the maximum recorded reading.

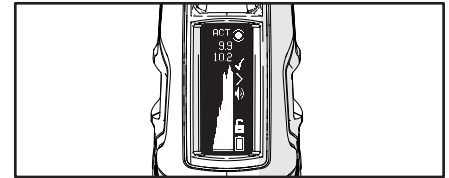

PEAK ROF SCREEN

This screen displays the peak ROF recorded over time, along with the latest recorded reading and the maximum recorded reading. The peak rate of fire is the rate of fire between each two consecutive shots. Hold the bottom pushbutton to zero the maximum recorded reading.



SPLASH SCREEN

This screen display the splash graphic which, by default, is the marker logo but can be modified or replaced by means of the E-Portal PC application.

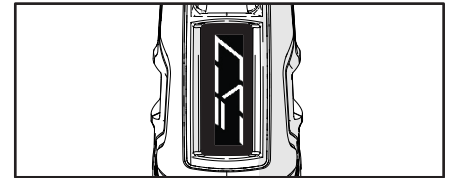

FIG.1

To access the settings menu, switch the marker on and then push and hold the **Select** button until the TURN OFF? menu item is displayed. Double-clicking will also access the menu if enabled.

The top level menu shown opposite shows all the available menu items, each having their own tiered adjustable parameters. See pages 54-58 for a complete menu tree.

The availability of some menu items is dependent upon the setting of other parameters [e.g. the RAMP SETUP menu is only available when FIRE MODE is set to RAMP].

Select BACK to return to the previous menu level. Select EXIT to leave the settings menu.

Select TURN OFF? to turn off the marker.

The layout and parameters shown in this manual are correct at the time of printing.

FIG.1

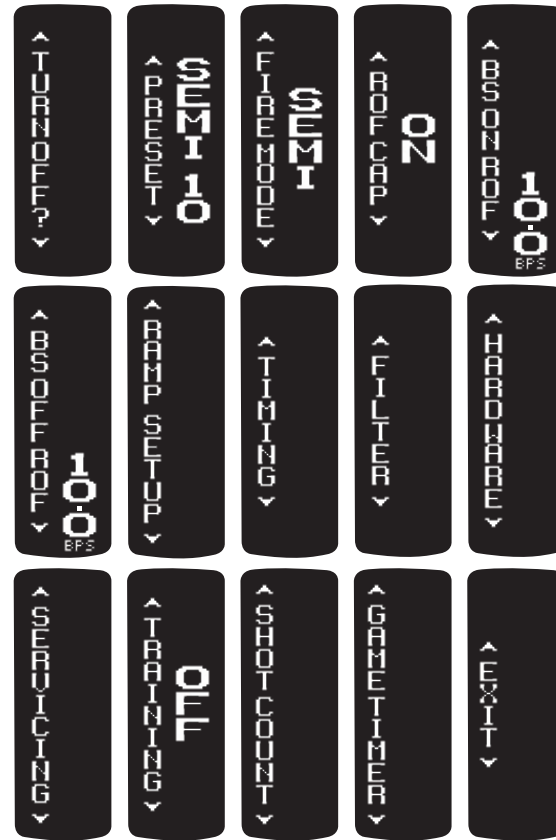

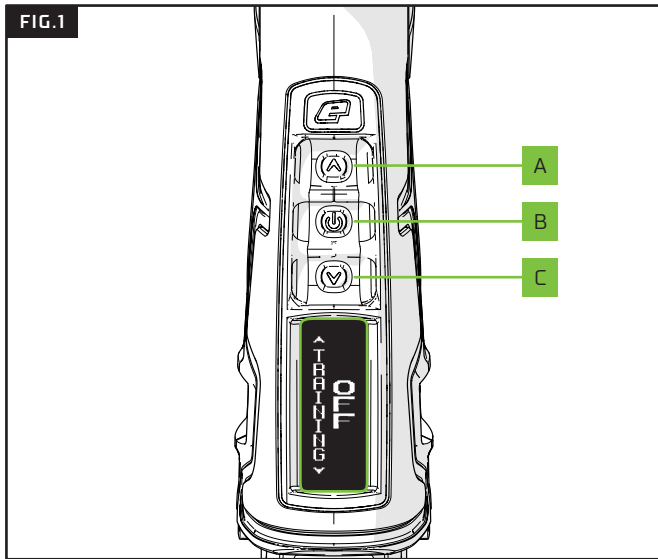
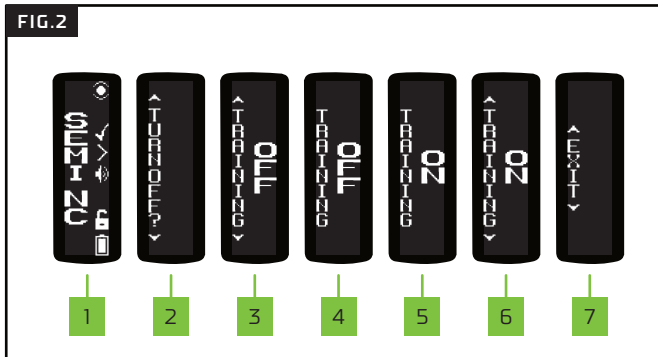

FIG.1

Once in a menu use the **Up** **A** and **Down** **C** buttons to navigate through the menu items.

Use the **Select** button **B** to select the item. If the item is an adjustable parameter then it can be adjusted with the **Up** and **Down** buttons and accepted with another push of the **Select** button.

FIG.2 EXAMPLE - CHANGING THE TRAINING PARAMETER



- 1 Turn the marker on and wait for the run screen to appear.
- 2 Push and hold **Select** until TURN OFF? appears on screen.
- 3 Use **Up** or **Down** to navigate to the TRAINING parameter.
- 4 Press **Select** to confirm the TRAINING parameter for adjustment. The arrows above the parameter will disappear.
- 5 Use **Up** and **Down** to scroll through the TRAINING parameter options [ON/OFF].
- 6 Use the **Select** button to confirm selection. The arrows above the parameter will now reappear.
- 7 Use **Up** or **Down** to find EXIT and press **Select** to return to the run screen.

PRESETS

A preset is made up of all of the parameters that control the way in which the marker fires. These parameters are:

- > FIRE MODE
- > ROF CAP
- > BS ON ROF
- > BS OFF ROF
- > RAMP TYPE
- > RAMP RATE
- > SEMI SHOTS
- > KICK IN
- > SUSTAIN
- > RESTART
- > TRAINING

Selecting a preset changes each of these parameters and so the marker can be quickly configured to comply with the rules laid down by any given league, tournament or field. There are 10 presets and any one can be modified by the user in order to customise the marker to their own requirements.

Any changes made will be saved.

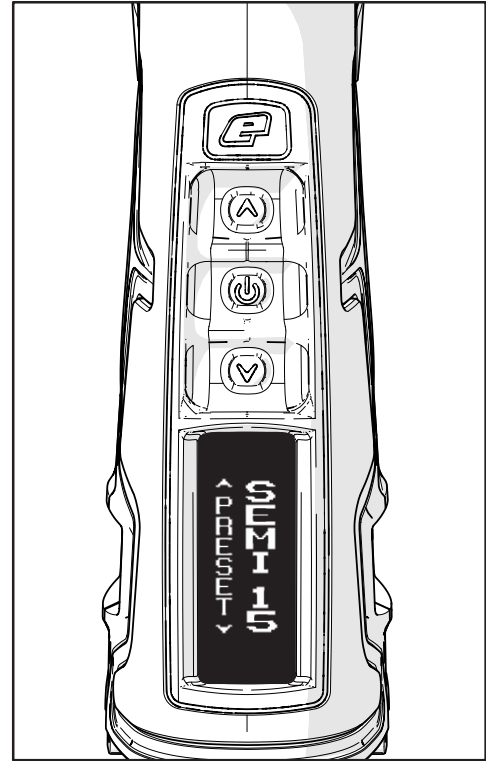

FACTORY PRESETS

The default list of presets is designed to cover all of the major tournament rules:

- > SEMI NC: Uncapped semi-automatic.
- > SEMI 10: Semi-automatic capped at 10 bps.
- > SEMI 15: Semi-automatic capped at 15 bps.
- > NXL 2016: Ramping capped at 10.2 bps, compliant with 2016 NXL rules.
- > PSP 2015: Ramping capped at 10.2 bps, compliant with 2015 PSP rules.
- > PSP FAST: PSP style ramping capped at 20.0 bps.
- > RETRO: NXL style ramping capped at 5.5 bps.
- > USER 1: User defined preset
- > USER 2: User defined preset
- > TRAIN: Uncapped semi-automatic training mode.

If the currently selected preset is a factory preset then a will be displayed on the run screen, otherwise a will be displayed. The presets can be restored to factory defaults by selecting FACTORY in the HARDWARE menu and choosing RESTORE.

FIG.1 – PRESET PARAMETER

Select the required preset from the list of available presets [above]. *

* Some presets may only be available in certain countries and on some models of the marker. All presets are correct at the time of printing.

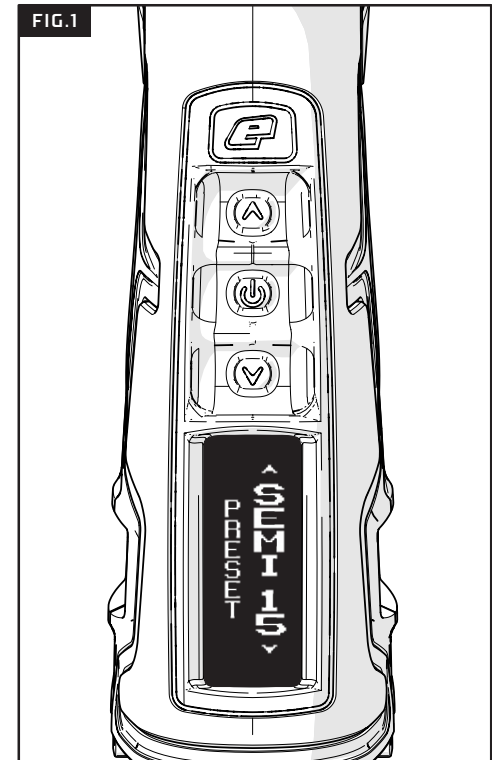

FIRE MODE PARAMETER

Sets the firing mode of the marker.

- > SEMI: One shot per trigger pull.
- > RAMP: Assisted firing with multiple shots per trigger pull under certain conditions.

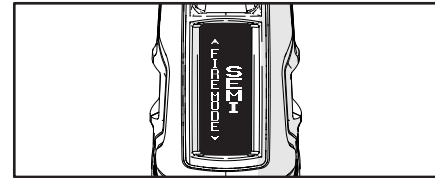
**ROF CAP PARAMETER**

The maximum rate of fire the marker can achieve.

- > ON: ROF limited to the value set by the BS ON ROF parameter.
- > OFF: ROF limited by loader speed.

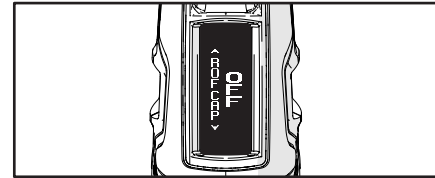
**BS ON ROF PARAMETER**

The maximum rate of fire that the marker can achieve with the breech sensor (BS) enabled. This parameter is only visible if the ROF CAP parameter is set to ON.

- > Range: 4.0 – 20.0 bps (balls per second) In 0.1 increments. ¹
 - 1 Always calibrate your ROF CAP parameters to the venue ROF meter to avoid penalties.

**BS OFF ROF PARAMETER**

The maximum rate of fire that the marker can achieve with breech sensor (BS) disabled. ¹

- > Range: 4.0 – 15.0 bps (balls per second) In 0.1 increments. ²
 - 1 Should be set to the slowest loader feed rate to avoid chopping paintballs.
 - 2 Always calibrate your ROF CAP parameters to the venue ROF meter to avoid penalties.

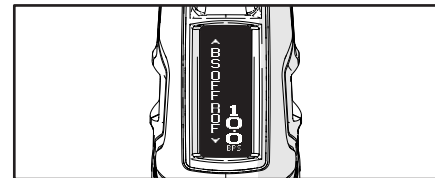

RAMP SETUP MENU

This menu is only visible when RAMP has been selected for the FIRE MODE parameter.

RAMP TYPE PARAMETER

Select the type of ramping required:

> STEP

The marker will fire in semi-automatic until a number of trigger pulls (set by SEMI SHOTS) have been made at a minimum pull rate (set by KICK IN). The marker will then fire at up to the maximum rate of fire (set by BS ON ROF) as long as the trigger is continually pulled at a required rate (set by SUSTAIN).

> LINEAR

The marker will fire in semi-automatic until a number of trigger pulls (set by SEMI SHOTS) have been made at a minimum pull rate (set by KICK IN). The rate of fire will then equal the rate of trigger pulls increased by a percentage (specified by RAMP RATE) up to a maximum rate of fire (set by BS ON ROF). Ramping is maintained as long as the trigger is continually pulled at a required rate (set by SUSTAIN).

RAMP RATE PARAMETER

Only visible when the RAMP TYPE parameter is set to LINEAR, this sets the percentage increase in rate of fire over rate of trigger pulls.

If the RAMP RATE is 50% and the trigger is pulled at 10 bps then the actual rate of fire is 15 bps (10 + 50%). This parameter can be set between 0 and 100% in 10% increments.

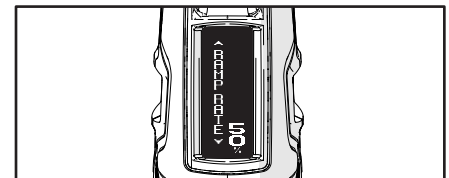
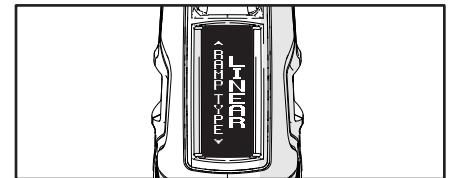
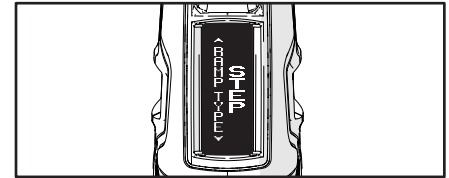
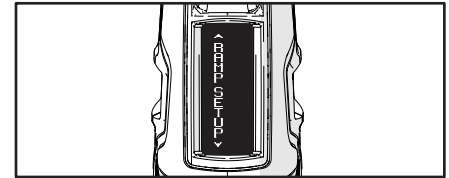

SEMI SHOTS PARAMETER

The number of shots in semi automatic required at the KICK IN rate in order to start ramping.

- > Range: 3 - 9 pulls in 1 pull increments.

**KICK IN PARAMETER**

The rate at which the trigger has to be pulled in order to start ramping.

- > Range : 3.3 - 10.0 pps (pulls per second) in 0.1 increments.

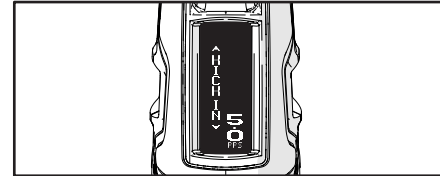
**SUSTAIN PARAMETER**

The rate at which the trigger must be continually pulled in order to maintain ramping.

- > Range : 3.3 - 10.0 pps (pulls per second) in 0.1 increments.

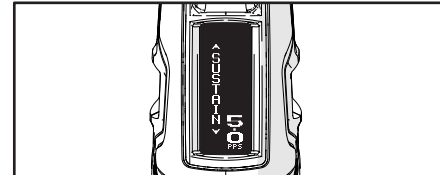
**RESTART PARAMETER**

The amount of time after the last trigger pull during which ramping can be restarted with a single trigger pull.

- > Range : 0.0 - 1.0 seconds in 0.1 increments.



TIMING MENU

The parameters on the TIMING menu control the energise time of the solenoid valve.

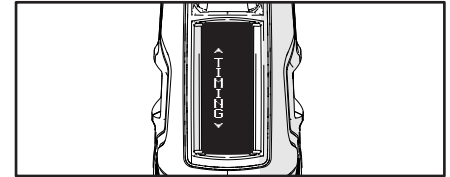

DWELL PARAMETER

The amount of time that the solenoid valve is energised during each firing cycle.

- > Range : 5.0 – 35.0 ms (milliseconds) in 0.1 increments.

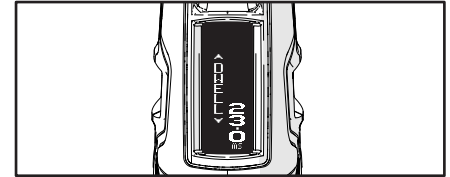

FSD COMP PARAMETER

'First Shot Drop-off' is a velocity drop of the first shot fired after the marker has been at rest. FSD COMP is added to the DWELL in order to compensate.

- > Range : 0.0 – 5.0 ms (milliseconds) in 0.1 increments.

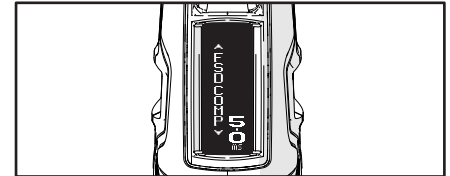

FSD DELAY PARAMETER

The amount of time the marker must be at rest before the FSD COMP is applied to a shot.

- > Range : 00:00 – 04:00 minutes in 1 second increments.

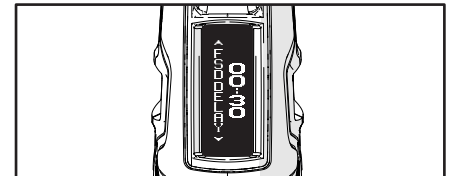

FILTER MENU

The FILTER parameters are used to tune the software filters to prevent the marker from firing, unless all of the necessary conditions are met.

Factory default settings are suitable for most set-ups however, certain loader and trigger set-ups may require filter adjustments.

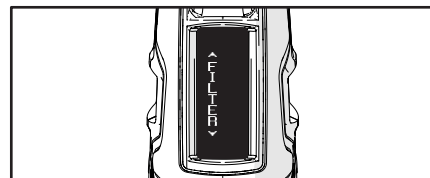

DEBOUNCE PARAMETER

Amount of trigger debounce. Changing this parameter directly changes the PULL TM and RELEASE TM parameters.

- > LEVEL1: Least filtering (most trigger bounce).
- > LEVEL9: Most filtering (least trigger bounce).

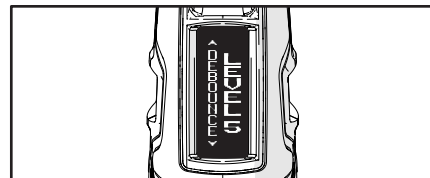

EMPTY PARAMETER

The amount of time that the breech has to be empty before the marker registers that it is actually empty.

- > Range : 1.0 - 20.0 ms (milliseconds) in 0.1 increments.



FULL PARAMETER

The amount of time that the breech has to be full (paintball in place) before the marker registers that it is actually full.

- > Range : 1.0 - 20.0 ms (milliseconds) in 0.1 increments.

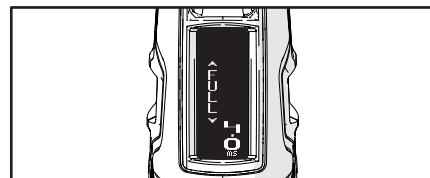

PULL TM PARAMETER

The minimum amount of time that the trigger must be pulled in order to be recognised as a valid trigger pull.

- > Range : 1.0 - 20.0 ms (milliseconds) in 0.1 increments.

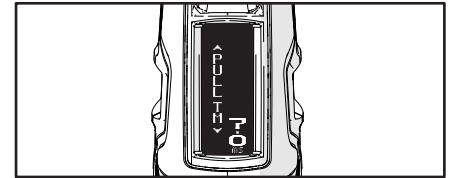

RELEASE TM PARAMETER

The minimum amount of time that the trigger must be released in order to be recognised as a valid trigger release.

- > Range : 1.0 - 20.0 ms (milliseconds) in 0.1 increments.

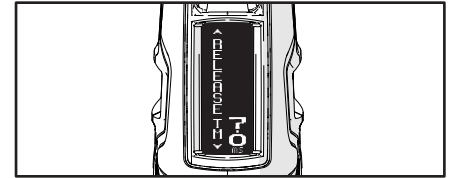

HARDWARE MENU

The **HARDWARE** menu contains parameters that are used to control the electronics hardware.

BLUETOOTH® PARAMETER

Enables the on-board Bluetooth® module.

- > ON : Enable Bluetooth®
- > OFF : Disable Bluetooth®

A blue LED indicates the Bluetooth® status.

- > Off : Disabled
- > Single flash : Enabled
- > Double flash : Connected

PIN CODE PARAMETER

Personal code used to secure communications with the E-Portal Lite smartphone app.

- > RANGE : 0000 - 9999 in increments of 1.

SOUND PARAMETER

Enables the on-board speaker.

- > ON : Sound enabled.
- > OFF : Sound disabled.

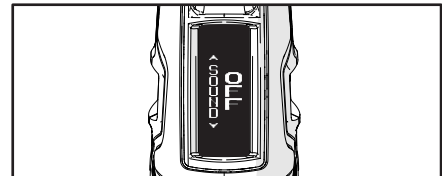
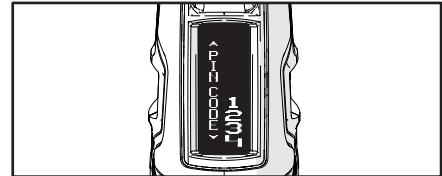
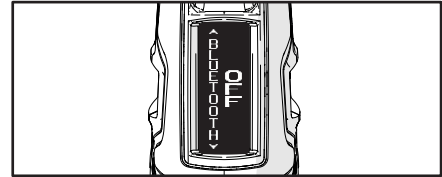
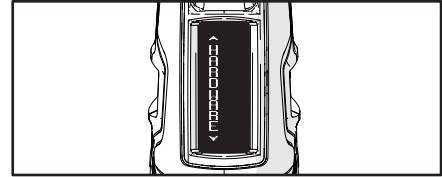

CLICK TONE PARAMETER

Pushbutton tones can be independently enabled. This item is only available if the SOUND parameter is set to ON.

- > ON : Tones enabled.
- > OFF : Tones disabled.

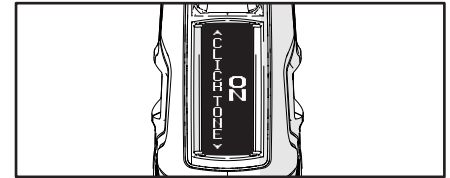

LED BRIGHT PARAMETER

Brightness of the breech sensor LED.

- > RANGE : 10 - 100% in increments of 5.

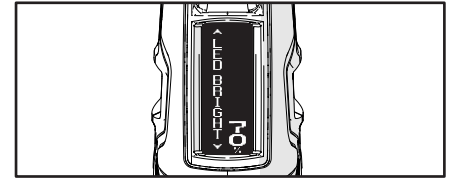

OLED DIM

The level to which the OLED dims a short time after the last button press.

- > RANGE : 50 - 100% in increments of 5.

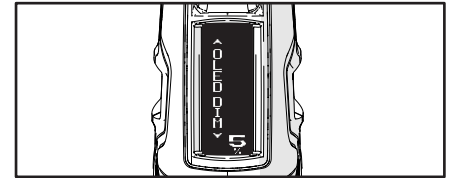

DIM TIME

The time after which the OLED dims to the level specified by the OLED DIM parameter.

- > RANGE : 00:01 - 00:20 in 1 second increments.

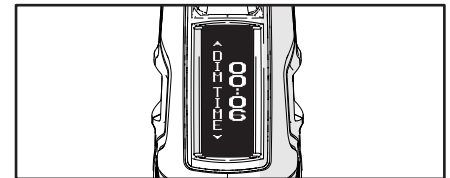

DBL CLICK PARAMETER

Sets where the **Select** button double-click can be used.

- > NONE : Double-click disabled.
- > POWER UP : Double-click to power up.
- > ALL : Double-click to power up and access the setup menu.

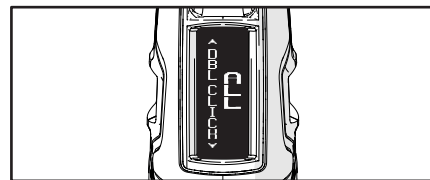
**AUTO OFF PARAMETER**

The amount of time that the marker can be idle before it switches itself off.

- > RANGE : 00:00 - 60:00 minutes in increments of 04:00. A value of 00:00 disables auto power off.

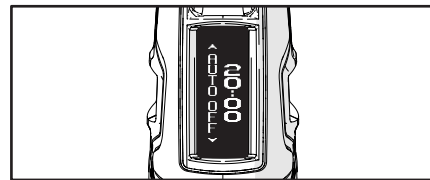
**FACTORY PARAMETER**

Restores all of the marker parameters back to their factory state. This will also force a search for, and configuration of, any new hardware.

- > NO : do not perform a reset.
 - > RESTORE : restore all parameters to their factory default value. 1
- 1 CAUTION: This will erase all saved settings.

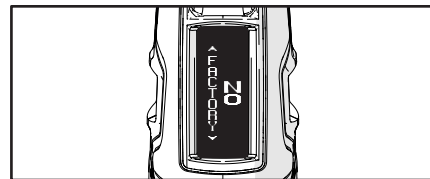

SERVICING MENU

This menu contains items associated with servicing reminders.

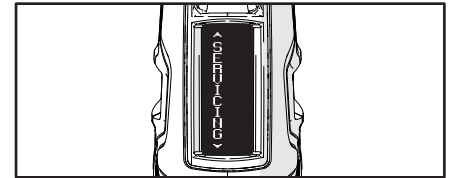

LUBRICATE PARAMETER

Sets the lubrication interval counter (NEXT LUBE) start value.

> RANGE : 0 - 25 (thousand) in increments of 1.

A value of 0 disables the counter.

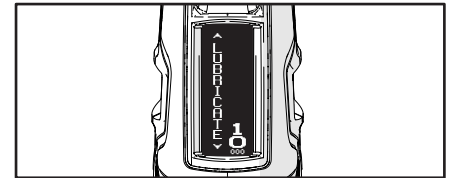

NEXT LUBE

This non-adjustable item displays the number of shots before the next lubrication is due.

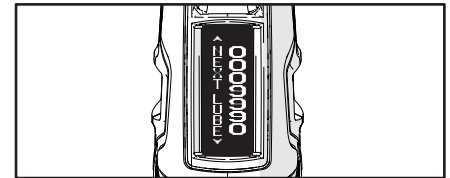

SERVICE PARAMETER

Sets the service interval counter (NEXT SERV) start value.

> RANGE : 0 - 100 (thousand) in increments of 1.

A value of 0 disables the counter.

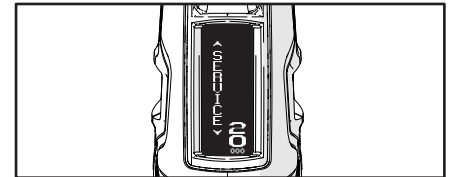

NEXT SERV

This non-adjustable item displays the number of shots before the next service is due.

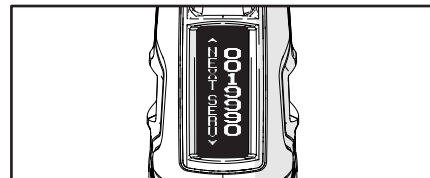

RESET PARAMETER

Resets the servicing counters.

- > NO : do not perform a reset.
- > LUBE : Reset the NEXT LUBE counter.
- > SERVICE : Resets both the NEXT LUBE and the NEXT SERV counters.



TRAINING PARAMETER

Simulates the firing cycle using an audible beep to represent a shot fired, allowing the user to practice their trigger technique without firing the marker.

- > ON : Training mode enabled.
- > OFF : Training mode disabled.

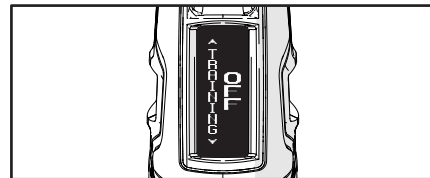

SHOT COUNT MENU

This menu contains items associated with the shot counter.

TOTAL SHOTS

This non-adjustable item displays the total number of times that the solenoid has been energised.

GAUGE PARAMETER

This toggles the visibility of the shot counter gauge graphic on the shot counter run screen.

- > ON : Gauge graphic enabled.
- > OFF : Gauge graphic disabled.

GAUGE MAX PARAMETER

Shot counter gauge start point.

- > RANGE : 100 - 2000 in increments of 10.

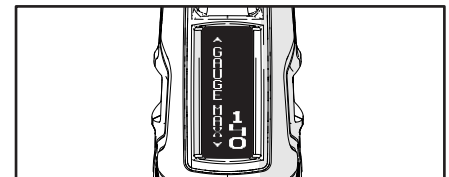
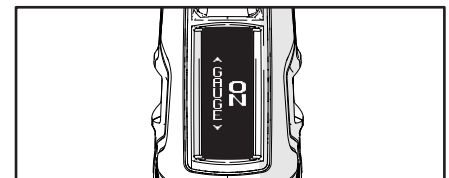
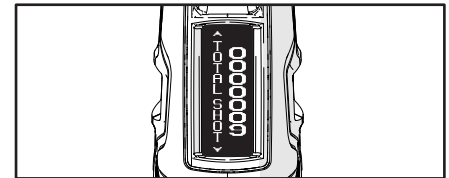
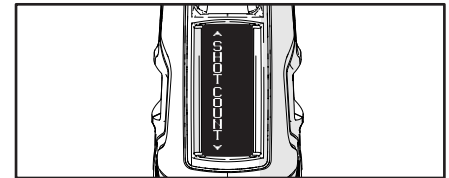

GAME TIMER MENU

The game timer menu contains items associated with the game timer.

GAME TIME

Countdown game timer start point.

- > RANGE : 00:00 - 60:00 minutes in increments of 00:10.

A value of 00:00 disables the game timer.

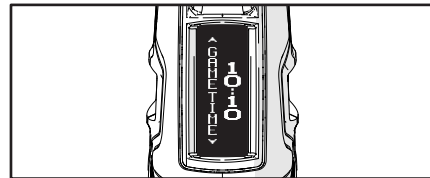
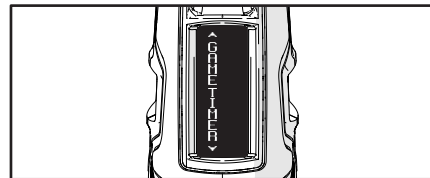

ALARM 1

An audible alarm is sounded when the game timer reaches this value.

- > RANGE : 00:00 - 60:00 minutes in increments of 00:10.
A value of 00:00 disables this alarm.

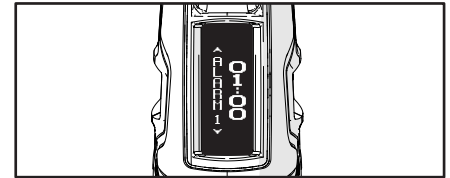

ALARM 2

An audible alarm is sounded when the game timer reaches this value.

- > RANGE : 00:00 - 60:00 minutes in increments of 00:10.
A value of 00:00 disables this alarm.

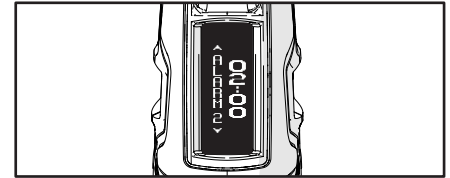





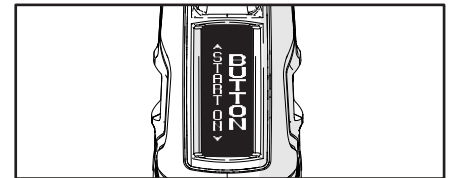

START ON

Sets the event which starts the game timer.

- > BUTTON: bottom button starts the timer.
- > TRIGGER: first trigger pull starts the timer.



The table below is an overview of the main menu, which is the top level of the settings menu structure. The following pages summarise all of the items within the menu structure.

TURN OFF?	Select to turn off the marker.
 PRESET	Select from a list of preset firing modes.
 FIRE MODE	Choose between semi-automatic and ramping firing modes.
 ROF CAP	Switch the rate of fire cap on or off.
 BS ON ROF *	Adjust the maximum achievable rate of fire when the breech sensor (BS) is on.
 BS OFF ROF	Adjust the maximum achievable rate of fire when the breech sensor (BS) is off.
RAMP SETUP *	Sub-menu for configuring the ramping firing mode.
TIMING	Sub-menu for adjusting the solenoid timing.
FILTER	Sub-menu for adjusting the trigger and breech sensor filters.
HARDWARE	Sub-menu for configuring hardware settings.
SERVICING	Sub-menu for defining and monitoring service intervals.
 TRAINING	Enable/disable the ability to test shoot the marker without energising the solenoid.
SHOT COUNT	Sub-menu for managing the shot counter.
GAME TIMER	Sub-menu for managing the game timer.
EXIT	Exit the menu and return to the run display.



The lock icon indicates items that can only be selected when the tournament lock is switched off. See page 19.

* The asterisk indicates items with visibility dependent upon the settings of other items.



TURN OFF?		Select to turn off the marker.
PRESET	SEMI NC	Semi-automatic with no rate of fire (rof) cap.
	SEMI 15	Semi-automatic with a 15 balls per second (bps) rate of fire cap.
	SEMI 10	Semi-automatic with a 10 bps rate of fire cap. (Default)
	NXL 2016	Settings compliant with the 2016 rulebook of the NXL.
	PSP 2015	Settings compliant with the 2015 rulebook of the PSP.
	PSP FAST	PSP style ramping with a 20 bps rate of fire cap.
	RETRO	NXL style ramping with a 5.5 bps rate of fire cap, for compliance with some 'mech' tournament rules.
	USER 1	User defined preset.
	USER 2	User defined preset.
	TRAIN	Semi-automatic training with no rate of fire cap.
FIRE MODE	SEMI	Semi-automatic firing mode. (Default)
	RAMP	Ramping firing mode.
ROF CAP	ON	Enable the rate of fire cap. (Default)
	OFF	Disable the rate of fire cap.
BS ON ROF *	4.0 - 20.0	With ROF CAP enabled, this is the maximum achievable rate of fire when the breach sensor is turned on. (Default 10.0)
BS OFF ROF *	4.0 - 15.0	Maximum achievable rate of fire when the breach sensor is turned off. (Default 10.0)

RAMP SETUP *			
RAMP TYPE	STEP	Step type ramping. (Default)	
	LINEAR	Linear type ramping.	
RAMP RATE*	0 - 100	Amount by which rate of fire increases over rate of trigger pulls, specified as a percentage. (Default 50)	
SEMI SHOTS	3 - 9	Number of consecutive semi-auto shots that have to be fired before ramping can start. (Default 3)	
KICK IN	3.3 - 10.0	Rate at which the trigger has to be pulled before ramping starts, specified in pulls per second. (Default 5.0)	
SUSTAIN	3.3 - 10.0	Rate at which the trigger has to be pulled to maintain ramping, specified in pulls per second. (Default 5.0)	
RESTART	0.0 - 1.0	Time after the last trigger pull during which ramping can be instantly restarted, specified in seconds. (Default 0.0)	
TIMING			
DWELL	5.0 - 35.0	Solenoid energise time, specified in milliseconds. (Default 23.0)	
FSD COMP	0.0 - 5.0	First shot drop-off compensation time, specified in milliseconds. (Default 5.0)	
FSD DELAY	00:00 - 04:00	First shot drop-off delay, specified in minutes. (Default 00:30)	
FILTER			
DEBOUNCE	LEVEL 9 - LEVEL 1	Trigger debounce level. LEVEL 9 has the greatest amount of trigger debounce filtering. (Default LEVEL 5)	
EMPTY	1.0 - 20.0	Minimum breach empty time for correct operation, specified in milliseconds. (Default 4.0)	
FULL	1.0 - 20.0	Minimum breach full time before the marker can fire, specified in milliseconds. (Default 4.0)	
PULL TM	1.0 - 20.0	Minimum trigger pull time for a valid pull, specified in milliseconds. (Default 7.0)	
RELEASE TM	1.0 - 20.0	Minimum trigger release time for a valid release, specified in milliseconds. (Default 7.0)	

HARDWARE

BLUETOOTH	ON	Bluetooth® enabled.
	OFF	Bluetooth® disabled. (Default)
PIN CODE	0000 - 9999	Security code for accessing the marker from E-Portal Lite. (Default 1234)
SOUND	ON	Enable sound from the internal speaker. (Default)
	OFF	Disable sound from the internal speaker.
CLICK TONE	ON	Enable button activation tones when SOUND is enabled. (Default)
	OFF	Disable button activation tones.
LED BRIGHT	50 - 100	Brightness of the LED indicator, specified as a percentage. (Default 70)
OLED DIM	50 - 100	Dimming level of the OLED display, specified as a percentage. (Default 50)
DIM TIME	00:01 - 00:20	Delay before the OLED display dims, specified in minutes. (Default 00:06)
DBL CLICK	NONE	Double-click functionality disabled.
	POWER UP	Double-clicking the SELECT pushbutton will power-up the marker.
	ALL	Double-clicking the SELECT pushbutton will power-up or display the Setup Menu. (Default)
AUTO OFF	00:00 - 60:00	Auto power-off time, specified in minutes. (Default 20:00)
RESET	NO	Do not reset.
	FACTORY	Reset all parameters to their factory state. CAUTION: This erases ALL changes.

SERVICING			
LUBRICATE	0 - 25	User-defined lubrication interval, specified in thousands of shots. (Default 10)	
NEXT LUBE	0 - 0025000	Shows the number of shots before the next lubrication is required (not adjustable).	
SERVICE	0 - 100	User-defined service interval, specified in thousands of shots. (Default 20)	
NEXT SERV	0 - 0100000	Shows the number of shots before the next service is required (not adjustable).	
RESET	NO	Do not perform a reset.	
	LUBE	Reset the number of shots before the next lubrication.	
	SERVICE	Reset the number of shots before both the next service and the next lubrication.	
TRAINING			
	ON	Training mode enabled.	
	OFF	Training mode disabled. (Default)	
SHOT COUNT			
TOTAL SHOT	0000000 - 9999999	Total shot count of the marker. Not adjustable.	
GAUGE	ON	Shot counter gauge enabled. (Default)	
	OFF	Shot counter gauge disabled.	
GAUGE MAX*	100 - 2000	Shot counter gauge maximum, specified in shots. (Default 140)	
GAME TIMER			
GAME TIME	00:00 - 60:00	Game timer start time, specified in minutes. (Default 10:10)	
ALARM 1	00:00 - 60:00	Alarm 1 activation time, specified in minutes. (Default 01:00)	
ALARM 2	00:00 - 60:00	Alarm 2 activation time, specified in minutes. (Default 00:00)	
START ON	BUTTON	Game timer starts when bottom button pushed. (Default)	
	TRIGGER	Game timer starts on first trigger pull after power on.	
EXIT			
		Exit the Settings menu.	

UNITED STATES

CONTAINS TRANSMITTER MODULE – FCC ID: A8TBM7152

This device complies with Part 15 of the FCC Rules. Operation is subject to the following two conditions: (1) this device may not cause harmful interference, and (2) this device must accept any interference received, including interference that may cause undesired operation.

This equipment has been tested and found to comply with the limits for a Class B digital device, pursuant to part 15 of the FCC Rules. These limits are designed to provide reasonable protection against harmful interference in a residential installation. This equipment generates, uses and can radiate radio frequency energy, and if not installed and used in accordance with the instructions, may cause harmful interference to radio communications. However, there is no guarantee that interference will not occur in a particular installation. If this equipment does cause harmful interference to radio or television reception, which can be determined by turning the equipment off and on, the user is encouraged to try to correct the interference by one or more of the following measures:

- Reorient or relocate the receiving antenna.
- Increase the separation between the equipment and receiver.
- Connect the equipment into an outlet on a circuit different from that to which the receiver is connected.
- Consult the dealer or an experienced radio/TV technician for help.

CANADA

CONTAINS TRANSMITTER MODULE – IC: 12246A-BM7152

This device complies with Industry Canada's license exempt RSS. Operation is subject to the following two conditions:

- (1) This device may not cause interference; and
- (2) This device must accept any interference, including interference that may cause undesired operation of the device.

Le présent appareil est conforme aux CNR d'Industrie Canada applicables aux appareils radio exempts de licence. L'exploitation est autorisée aux deux conditions suivantes:

- (1) l'appareil ne doit pas produire de brouillage;
- (2) l'utilisateur de l'appareil doit accepter tout brouillage radioélectrique subi, même si le brouillage est susceptible d'en compromettre le fonctionnement.

EUROPE

Compliance testing for transmitter module:

CERTIFICATION	STANDARDS	ARTICLE	LABORATORY	REPORT NUMBER
Safety	EN60950-1:2006 A11:2009/A1:2010/ A12:2011/A2:2013	(3.1(a))	TUV Rheinland	10053210 001
Health	EN 62479:2010			10053433 001
EMC	EN 301 489-1 V1.9.2	(3.1(b))		10052964 001
	EN 301 489-17 V2.2.1			
Radio	EN 300 328 V1.9.1	(3.2)		10053433 001
Notified body opinion	CE0197			10048936 001

E-Portal is a PC application that lets you connect to your marker via a USB cable. Amongst other things you can use E-Portal to:

- 1 Upgrade the marker firmware.
- 2 Change the start-up splash screen.
- 3 Modify control parameters.

FIG-1

To access the USB Micro-B connector **A** remove the grips (see page 16) and connect the correct USB cable.

For E-Portal instructions and software download information visit planetecclipse.com/eportal.

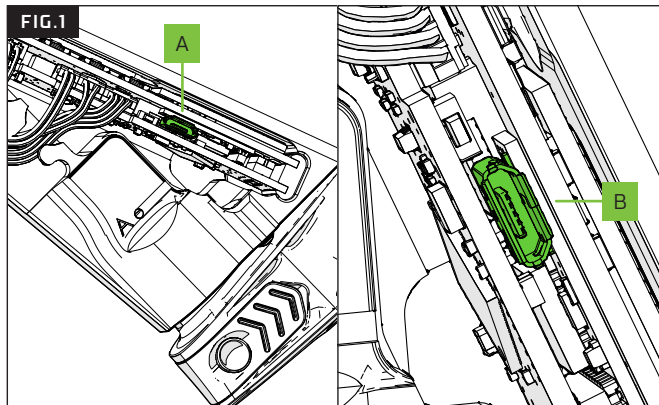

SYSTEM REQUIREMENTS

Monitor Resolution – 1024x768 or higher.
1GHz processor.
1Gb RAM.
Microsoft® Windows® 7 / 8 / 10 / 11.
10Mb of storage space.

A USB data cable is required to connect the marker to a PC.
Be wary of charging cables that may not have the necessary data connections. No USB cable is supplied with the marker.

DOWNLOAD:
PLANETECLIPSE.COM/EPORTAL

WARNING!

Always make sure that the marker is fully unloaded and the air system is disconnected, with a barrel blocking device installed, before connecting to a PC.



E-Portal Lite is a mobile application that lets you connect to your marker via Bluetooth® and modify your marker control parameters.

For E-Portal Lite instructions and software download information visit planetecclipse.com/eportal/eplite.

E-Portal Lite can be downloaded from the App Store.

SYSTEM REQUIREMENTS

iOS device (iPhone / iPad).

iOS 13.0 or later.

APP STORE:
ECLIPSE E-PORTAL LITE

WARNING!

Always make sure your marker is fully unloaded and the air system is disconnected, with a barrel blocking device installed, before connecting to E-Portal Lite.

FIG.1

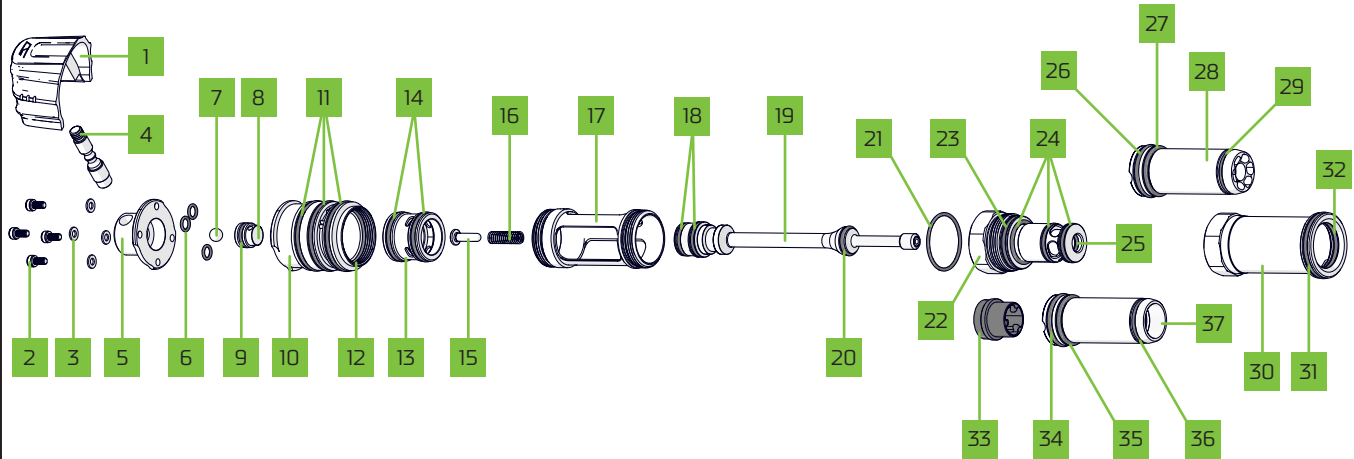

- 1 Bolt bonnet
- 2 Switch body cap screws (x4)
M2.5 x 8 cap head socket
- 3 M2.5 spring washers
- 4 Bolt pin
- 5 Switch body cap
- 6 4 x 1 NBR70 (x3)
- 7 5mm ball bearing
- 8 Plunger
- 9 #010 NBR70
- 10 Switch body
- 11 #021 NBR70 (x3)
- 12 20 x 1.2 NBR70 (internal)
- 13 Switch
- 14 #016 NBR70 (x2)
- 15 Spring guide
- 16 Spool spring
- 17 Joiner
- 18 #012 NBR70 (x2)
- 19 Spool
- 20 #011 NBR70
- 21 20 x 1.2 NBR70 (internal)
- 22 Bolt guide
- 23 #017 NBR70
- 24 #013 NBR70 (x3)
- 25 6 x 1.5 NBR70 (internal)
- 26 14 x 2 NBR70
- 27 #015 NBR90
- 28 Hard bolt
- 29 #013 NBR70
- 30 Can
- 31 #020 NBR70
- 32 #017 NBR70 (internal)
- 33 Cure FT bolt tip
- 34 14 x 2 NBR70
- 35 #015 NBR90
- 36 #013 NBR70
- 37 Cure FT bolt

FIG.1

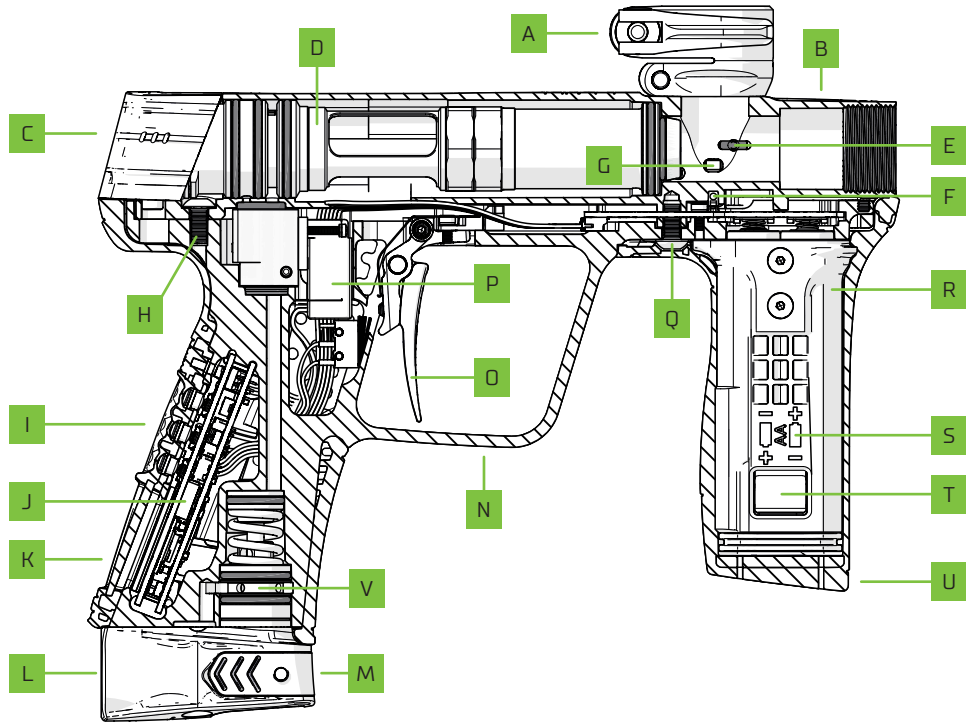

FIG.1

- A** Locating clamping feed tube assembly
- B** Marker body
- C** Bolt bonnet
- D** Drivetrain assembly
- E** Rubber detent
- F** Breech Sensor (BS)
- G** Light pipe
- H** Rear frame screw
- I** Navigation console
- J** Modular Marker Electronics (MME)
- K** OLED display

- L** Push On Purge System (POPS) body
- M** Push On Purge System (POPS) bonnet
- N** Frame assembly
- O** Trigger assembly
- P** Solenoid assembly
- Q** Front frame screw
- R** AA Battery housing (foregrip)
- S** AA battery orientation guide
- T** Battery retainer (locking tabs)
- U** Foregrip rubber sleeve
- V** Regulator assembly

>

- BATTERY**, 04, 09, 13, 16, 18, 28-30, 65
- BOLT**, 02, 04, 07, 16-17, 25, 28-30, 63-65
- BREECH SENSOR**, 04, 08-10, 15, 20, 29-31, 40, 47, 54-55, 65
- BS COVER**, 20
- BS DISABLED**, 10, 15
- BS FAULT**, 10
- BS STATUS INDICATOR**, 04, 08, 15
- CIRCUIT BOARD**, 16
- DEBOUNCE**, 30, 44, 56
- DRAINED BATTERY**, 13
- DWELL**, 28, 30, 43, 56
- E-PORTAL**, 04, 23, 35, 46, 57, 60-61
- FACTORY PRESET**, 04, 09, 11, 39
- FAULT FINDING**, 04, 28-31
- FEEDNECK**, 07, 25
- FILTER**, 30, 44, 54, 56
- FIRE MODE**, 36, 40-41, 54-55
- FIRMWARE**, 04, 11, 14, 23, 60
- FOREGRIP**, 18, 20-21, 65
- FSD COMP**, 28, 43, 56
- FSD DELAY**, 43, 56
- GAME TIMER**, 34, 52-54, 58
- GRIPS**, 04, 16-17, 19, 60
- KICK IN**, 38, 41-42, 56
- LED**, 08, 15, 46-47, 57
- LPR**, 65
- LUBRICATION**, 07, 11, 25, 28-30, 32, 49, 58
- NAVIGATION CONSOLE**, 08, 15, 30, 65
- NXL**, 39, 55
- OLED**, 04, 08, 10-13, 15, 19, 34-35, 47, 57, 65

ON/OFF, 02, 04, 07-08, 37

POPS, 07, 25, 28, 30, 65

PSP, 39, 55

PULL TM, 44-45, 56

RAMP, 36, 38-42, 54-56

REGULATOR, 07, 25, 65

RELEASE TM, 45, 56

ROF, 10, 35, 38, 41, 54-55

ROF CAP, 38, 40, 54-55

S63, 07

SAFETY, 02-03, 07, 26, 59

SELECT, 08, 10-11, 14, 23, 30-31, 36-39, 41, 48, 54-55, 57

SEMI, 38-39, 41-42, 54-56

SERVICE, 04-05, 09, 11, 27-28, 32, 49-50, 54, 58

SERVICE INDICATOR, 09, 11

SHOT COUNTER, 34, 51, 54, 58

SOLENOID, 43, 51, 54, 56

SOUND, 09, 12, 34, 46-47, 53, 57

SPOOL, 28-30, 63

SUPPORT, 05, 27

SUSTAIN, 08, 38, 41-42, 56

TIMING, 02, 34-35, 36, 39, 42-45, 47-48, 51-52, 54, 56-58

TOURNAMENT LOCK, 13, 16, 19, 54

TRAINING, 10, 37-39, 50, 54-55, 58

TRIGGER, 08-09, 12, 22, 41-42, 44-45, 53-54, 58

TRIGGER DETECTION INDICATOR, 09, 12

TUNING, 44

USB, 60

VALVE, 43

WARRANTY, 05, 27



GET MORE
PLANETECLIPSE.COM



GET
MORE

SCAN FOR MORE
PLANET ECLIPSE
GOODNESS.



802.086.A-000

THIS PRODUCT IS COVERED BY AND/OR LICENSED UNDER ONE OR MORE OF THE FOLLOWING PATENTS:

G.B. PATENTS:

2,342,710; 2,345,953; 2,352,022; 2,391,292; 2,391,063;

U.S. PATENTS:

7,836,873; 7,603,995; 7,073,284; 8,104,463; 7,509,953; 7,921,839; 7,089,697; 7,866,307; 8,082,912; 7,076,906; 7,607,424; 7,980,238; 8,960,175; 8,528,877; 8,201,547; 8,397,706; 8,210,160; 7,073,284; 6,311,682; 6,748,938; 6,860,259; 6,941,693; 6,973,748; 5,881,707; 5,967,133; 6,035,843; 6,474,326; 6,637,421; 6,644,295; 6,810,871; 6,901,923; 7,121,272; 7,100,593; 7,610,908; 7,603,997; 7,946,285; 6,349,711; 7,044,119; 7,185,646; 7,461,646; 7,556,032; 7,591,262; 7,617,819; 7,617,820; 7,640,925; 7,640,926; 7,866,308;

APPLICATION NUMBERS:

12/256,832; 12/613,958; 12/493,777; 11/654,721; 11/747,107; 12/503,504; 11/781,821; 60/832,548; 11/965,886; 10/280,115

Additional U.S. and International Patents may be pending.

UK

Unit 14 Premier Park, Acheson Way
Trafford Park Road, Trafford Park
Manchester, M17 1GA, England
T: +44(0) 161 872 5572
planeteclipse.com/contact

USA

130 Franklin Street
Building L4 & L5
Warren, RI, 02885, USA
T: +1 401 247 9061
planeteclipse.com/contact

EUROPE

PE--Paintball.De Gmbh
Langenberger Str. 9 Tor 5 & 6
Düsseldorf 40233, Germany
T: +49 (0) 211 210 230-0
planeteclipse.com/contact

Planet Eclipse Ltd.

5171_EN_PE-CS3-Manual-v1